

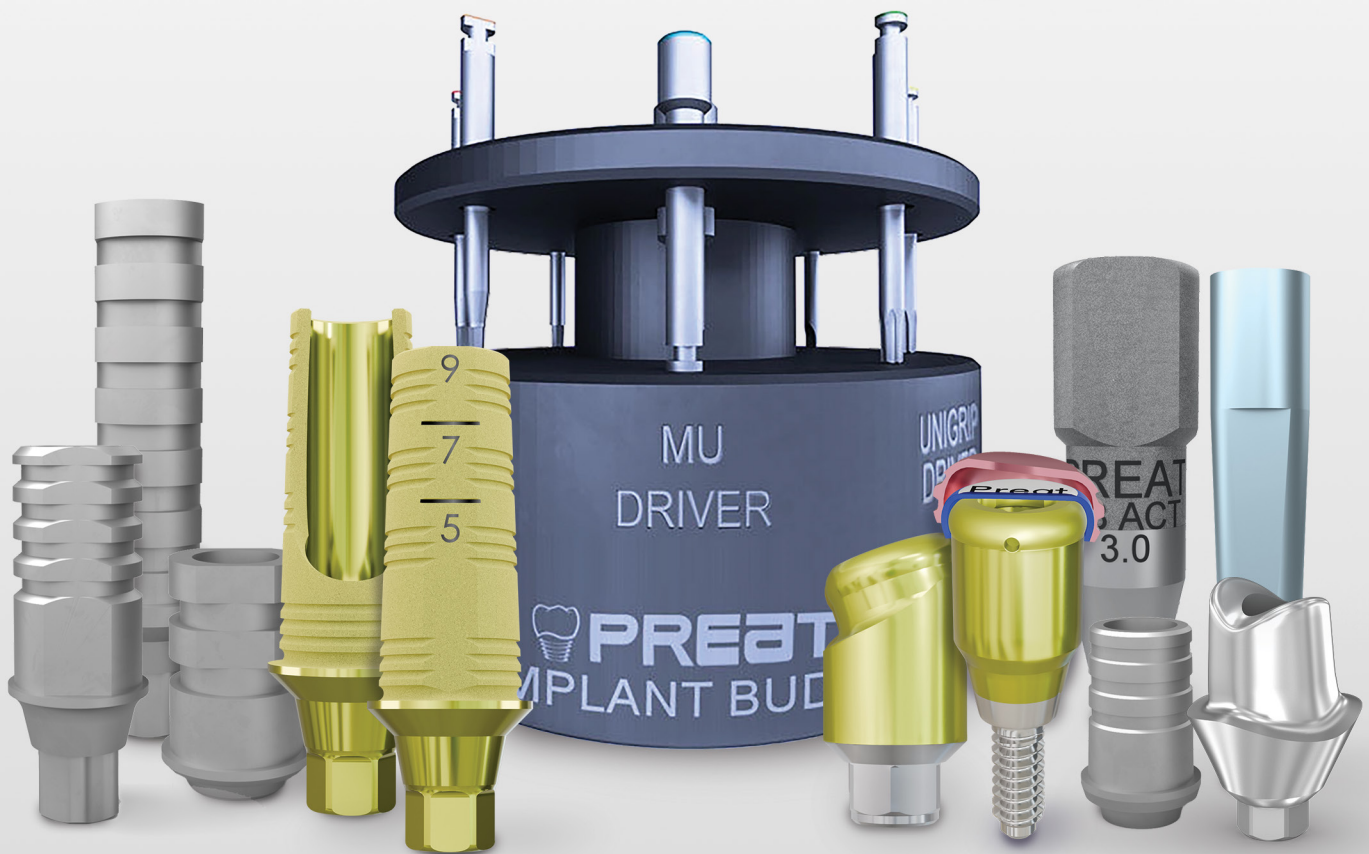

# RESTORATIVE PROSTHETIC PRODUCT BOOK

14<sup>TH</sup> EDITION



**LABORATORY & CLINICAL SOLUTIONS**

IMPLANT PARTS | ATTACHMENTS | DIGITAL DENTISTRY

# Two generations and over 40 years of service.

Founded in 1980, Preat Corporation has grown from a family-owned business into a trusted leader in dental attachments, implant components and prosthetic solutions.

Known for innovation and expert support, Preat pioneered attachment systems that enhanced function, esthetics and patient comfort. Over the years, the company expanded into custom abutments and implant parts, partnering with leading manufacturers. In 2020, Preat joined Young Innovations, further strengthening its ability to deliver innovative solutions and outstanding customer service.



*Scan to learn more about Preat's history!*

Thomas Bormes, Founder, with his son, Chris Bormes, who served as President from 2011-2020.



## The Preat Promise



### Clinical Choice

With a full portfolio of restorative options for single-tooth to full arch cases, we give you the freedom to choose the best solution for each patient.



### Expert Support

Our restorative experts are here to help you identify implants, review your restorative options and even answer questions years after the restoration was placed – that's what we call lifecycle support and it's what we do every day.



### Easy Ordering

We'll help you find the right item to fit your restorative plan. Our broad portfolio also means we can be your one-stop shop for implant restorations to make ordering even easier!



### Lab Trusted

Over the decades, we've earned the trust of dental laboratories. We're here to be a true part of your implant restorative team.



### Quality Tested

We know quality is essential. Preat products are tested to the highest standards and meet or exceed the fit of OEM providers.



### Timely Delivery

99.4% on-time and accurate delivery means you and your patient receive exactly what you need when you need it. That's why we do what we do.

# TABLE OF CONTENTS

## ATTACHMENTS

### OVERDENTURE BARS

<a href="#">Hader Bar</a> .....	6
<a href="#">Ackermann MD &amp; BL</a> .....	11
<a href="#">Universal Plunger Loc</a> .....	12
<a href="#">LOCATOR® Bar</a> .....	33
<a href="#">Clix</a> .....	26
<a href="#">Sagix</a> .....	55
<a href="#">OT Equator®</a> .....	52
<a href="#">Ceka and Ceka Revax</a> .....	59

### OVERDENTURE STUDS

<a href="#">PreatLoc™</a> .....	14
<a href="#">O-Ring Size Chart</a> .....	21
<a href="#">O-Rings/ OSO</a> .....	22
<a href="#">Sphero Reconstruction Kits</a> .....	13
<a href="#">LOCATOR®</a> .....	31
<a href="#">Ceka and Ceka Revax</a> .....	59

### IMPLANT ABUTMENTS / ATTACHMENTS/ PREATLOC™

<a href="#">O-Ring Abutment</a> .....	24
<a href="#">Clix</a> .....	26
<a href="#">LOCATOR® Abutment</a> .....	37
<a href="#">LOCATOR R-Tx®</a> .....	45
<a href="#">LOCATOR® Overdenture Implant System</a> .....	50
<a href="#">OT Equator®</a> .....	52
<a href="#">Sphero Flex/ Sphero Block</a> .....	53

## **EXTRACORONAL ATTACHMENTS** *(for removable partial dentures)*

<a href="#">Sphero Retrofit Kit</a> .....	55
<a href="#">Sagix</a> .....	55
<a href="#">Vertex</a> .....	57
<a href="#">American Mini (Mini Dalbo)</a> .....	57
<a href="#">O-Ring Distal Extension Attachment</a> .....	58
<a href="#">Mays® Unilateral</a> .....	58
<a href="#">Universal IC Attachment</a> .....	59
<a href="#">Ceka and Ceka Revax</a> .....	59

## **CROWN & BRIDGE SPECIALTY**

<a href="#">Splintastik</a> .....	61
<a href="#">Double Mandrel BPD</a> .....	61

## **FIBER TECHNOLOGY**

<a href="#">TriLor® High Performance Polymer</a> .....	63
--------------------------------------------------------	----

## **CLINICAL SPECIALTY**

<a href="#">Attachment Pick Up Material</a> .....	64
<a href="#">Chairside® Block Out</a> .....	64
<a href="#">Denture Removal Tool</a> .....	64
<a href="#">Perma Ret</a> .....	65
<a href="#">Pro Blue NTR Polish</a> .....	65

## **CAD-CAM BAR SOLUTIONS**

<a href="#">Attachment Options</a> .....	66
------------------------------------------	----

# IMPLANT PROSTHETICS

<a href="#">Quick Reference Chart</a> .....	70
<a href="#">3i</a> <sup>®</sup> .....	72
<a href="#">ACE Surgical</a> <sup>®</sup> .....	79
<a href="#">Ankylos</a> <sup>®</sup> .....	80
<a href="#">Astra</a> <sup>®</sup> .....	82
<a href="#">Astra Tech EV</a> .....	87
<a href="#">BioHorizons</a> <sup>®</sup> .....	97
<a href="#">Bio-Lok</a> <sup>®</sup> .....	96
<a href="#">Blue Sky Bio</a> <sup>®</sup> .....	96
<a href="#">Branemark</a> <sup>®</sup> .....	98
<a href="#">Camlog</a> <sup>®</sup> .....	100
<a href="#">Glidewell Laboratories</a> <sup>®</sup> .....	106
<a href="#">Hiossen</a> <sup>®</sup> .....	107
<a href="#">Hi-Tec</a> <sup>®</sup> .....	117
<a href="#">Implant Direct</a> <sup>®</sup> .....	112
<a href="#">Keystone</a> <sup>®</sup> .....	114
<a href="#">Lifecore</a> <sup>®</sup> .....	117
<a href="#">MegaGen</a> <sup>®</sup> .....	119
<a href="#">MIS</a> <sup>®</sup> .....	121
<a href="#">Multi-Unit Components</a> .....	122
<a href="#">Neodent</a> <sup>®</sup> .....	126
<a href="#">Neoss</a> <sup>®</sup> .....	128
<a href="#">Nobel Biocare</a> <sup>®</sup> .....	128
<a href="#">Southern</a> <sup>®</sup> .....	142
<a href="#">Sterngold</a> <sup>®</sup> .....	142
<a href="#">Straumann</a> <sup>®</sup> .....	143
<a href="#">Zimmer</a> <sup>®</sup> .....	153

## IMPLANT DRIVERS AND TOOLS

<a href="#">Implant Buddy</a> .....	159
<a href="#">Implant Drivers</a> .....	160
<a href="#">Cuff Height and Angulation Tool Set</a> .....	159

## RESOURCES

<a href="#">Alloy Chart</a> .....	67
<a href="#">Implant Compatibility Chart</a> .....	162
<a href="#">Implant Driver Size</a> .....	159
<a href="#">Implant Prosthetics Quick Reference Chart</a> .....	70
<a href="#">O-Ring Replacement Size Chart</a> .....	21
<a href="#">Torque Value Chart</a> .....	170

# HADER BARS

The Hader Bar is the most popular and versatile bar attachment in the world as it is low profile, provides secure retention options, and is simple to service!

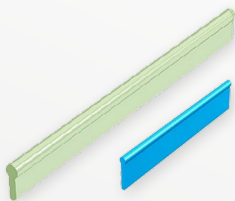

## BAR PATTERNS

- » Available in standard and short heights
- » Plastic-wax is ideal for fast set investment

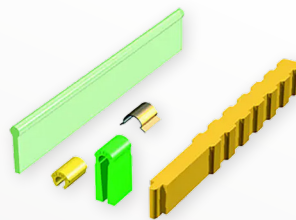

## COMBO KIT

*Everything needed for one bar case*

- » 1 Plastic Bar Pattern
- » 2 Female Riders
- » 2 Metal Housings (either style)
- » 2 Processing Spacers



## ALUMINUM ANALOG BAR

- » For relines, repairs, and making new prostheses

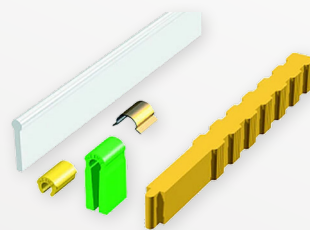

## HADER BAR SERVICING KIT

*Ideal for relines, rebases, repairs, or fabricating a new overdenture on existing bars or CAD-CAM bars*

- » 1 Delrin Analog Bar
- » 2 Female Riders
- » 2 Metal Housings (either style)
- » 2 Processing Spacers



## HADER BAR MANDREL

- » To assure parallelism between multiple bar segments

## PROCESSING SPACER

- » The processing spacer will prevent the over extension of acrylic which inhibits flexation of the female ride



## HOUSINGS

*Easy and accurate alignment of riders and housings with space saving options.*

## FEMALE RIDERS

Retentions of female riders

- » **Yellow**-standard
- » **White**-decreased
- » **Red**-increased
- » **Blue**-for worn bars



## METAL CLIPS

*Ackermann gold and stainless and C118 gold and stainless*

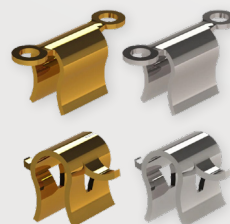

# Why Hader Bars are the Best Option for Bar Overdentures

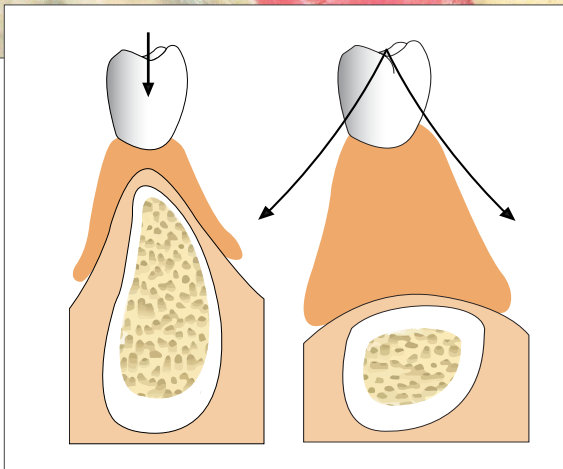
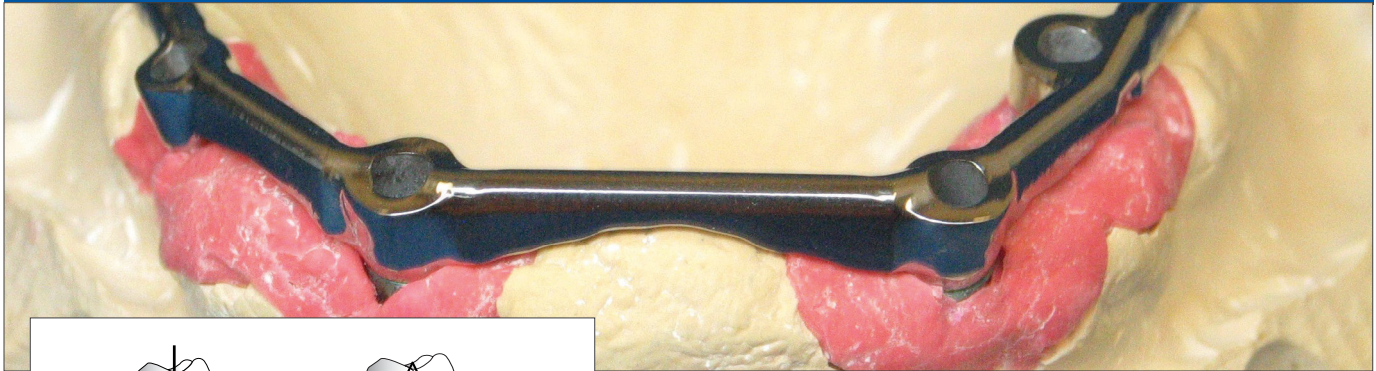

## INDICATIONS

- » In the maxillae, the bone quality and quantity often dictates the use of a bar to protect the implants in weaker bone via splinting.
- » In the resorbed mandible, the atrophied ridge can not be engaged by the denture flange and therefore does not provide prosthesis stability.
- » Extremely divergent implants are easier to accommodate with a bar overdenture.

## ADVANTAGES OF THE HADER BAR

### Flexibility in Prostheses Function

- » Metal Ackermann clips provide both vertical and rotational movement, ideal for 2 abutments bar with a single straight section and for protecting abutments.
- » Plastic Hader clips provide rotational movement. Ideal for restorations utilizing multiple bar sections and/or for rigid/fully abutment supported prostheses.

### Space Saving

- » Total vertical height of bar, 2.5mm.
- » Total vertical of attachments, 1.5mm.
- » Total width of attachment, 4.2mm.

### Easy to Service

- » 4 retentions of plastic clips to provide patient specific retention  
*Replacing a Hader clip can be done in less than 30 seconds*
- » 2 designs and 2 alloys of metal Ackermann clips

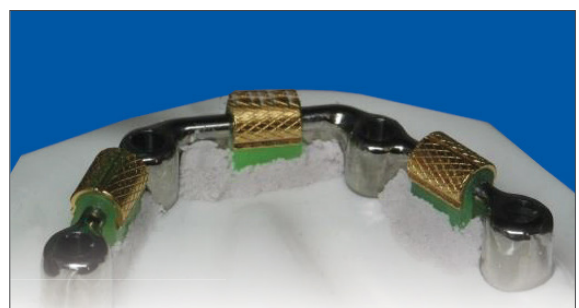
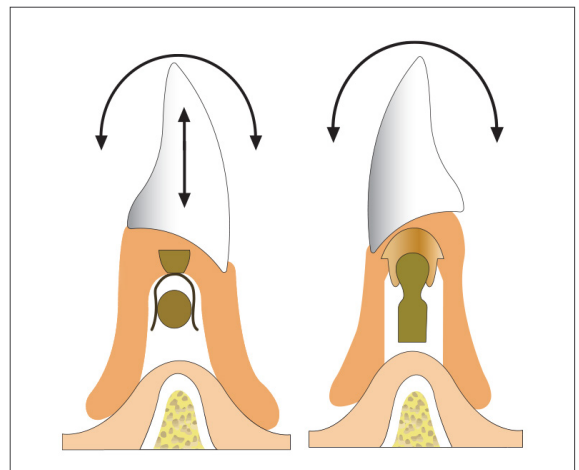

# ATTACHMENTS

## OVERDENTURE BAR ATTACHMENTS

### DIRECT RETAINERS

**Hader Bar Attachment**  
4mm↑ x 3mm



**Dolder Bar Attachment**  
4mm↑ x 3.5mm



4 Retention clips provide rotational movement on the bar



**Ackermann Bar Attachment**—  
5.5mm↑ x 4.5mm  
Vertical movement

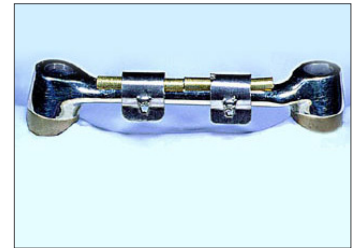

Vertical & Rotation motion

### ON TOP OF BAR

**LOCATOR® Attachment**  
4mm↑ x 5.5mm

8 Retention Inserts. Attachment can hinge, have vertical and rotational movement.



**Clix Attachment**  
4mm↑ x 4mm

Attachment can hinge, have vertical and rotational movement.



**OT Equator® Attachment**  
5.5mm↑ x 4.5mm

System can hinge, have vertical and rotational movement.



### OFFSET ATTACHMENTS

**Universal Plunger Loc**  
2.5mm↑ x 4mm

Can be rigid or resilient.



**Sagix Attachment**  
3.1mm↑ x 3mm

Attachment can hinge and rotate.

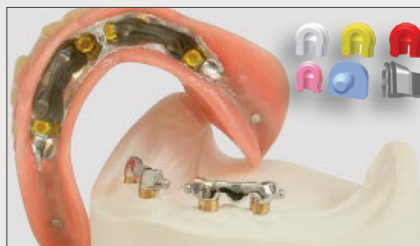

**Vertix Attachment**  
3.5mm↑ x 3mm

Allows vertical movement.



**Hader Bar:** the most popular and versatile bar attachment in the world. Low profile, secure retention options, and simple servicing! 3.5mm tall 4.20mm Ø housing

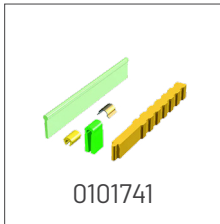
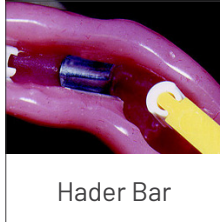
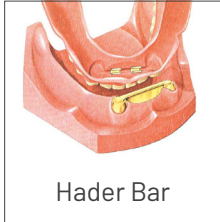

Hader Bar	
Item #	Product
0101701	Hader Bar Kit 2 castable bars, 6 yellow riders, 6 green processing, 1 insertion tool
0101750	Hader Bar Master Kit 6 castable bar, 6 alignment metal housings, 6 yellow riders, 6 green processing, 1 insertion tool
0101741	Hader Combo Kit 1 castable bar, 2 metal housings, 2 yellow riders, 2 green processing, and 1 insertion tool
0101742	Hader Alignment Combo Kit 1 castable bar, 2 alignment metal housings, 2 yellow riders, 2 green processing, 1 insertion tool
0101745	Hader Servicing Kit Delrin Analog, 2 metal housings, 2 yellow riders, 2 green processing, 1 insertion tool
0101746	Hader Bar Alignment Servicing Kit 1 Delrin Analog, 2 alignment housing, 2 yellow riders, 2 green processing, 1 insertion tool
0101704-6	Hader Plastic Bar Patterns (Standard)(6-Pack)
0101704-50	Hader Plastic Bar Patterns (Standard)(50-Pack)
0101709-6	Hader Plastic Bar Pattern (Short)(6-Pack)

# ATTACHMENTS

## OVERDENTURE BARS

10

Hader Bar

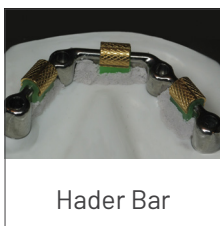
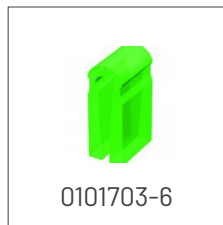
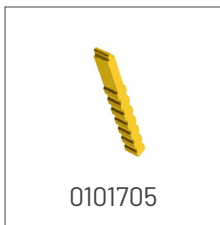
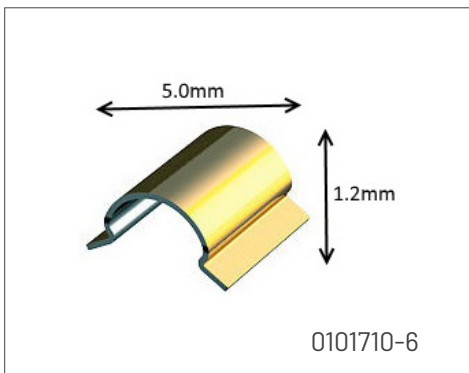
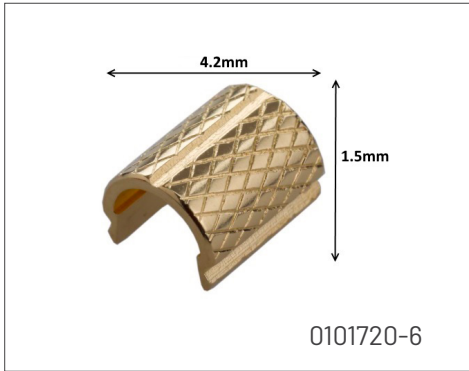

### Hader Bar

Item #	Product
0101709-50	Hader Plastic Bar Pattern (Short)(50-Pack)
0101775	Hader Aluminum Analog
0101705	Hader Insertion Tool
0101703-6	Hader Green Processing Spacers (6-Pack)
0101703-24	Hader Green Processing Spacers (24-Pack)
0101703-50	Hader Green Processing Spacers (50-Pack)
0101720-6	Hader Alignment Housing (6-Pack)
0101720-24	Hader Alignment Housing (24-Pack)
0101720-50	Hader Alignment Housing (50-Pack)
0101710-6	Hader Metal Housings (6-Pack)
0101710-24	Hader Metal Housings (24-Pack)
0101710-50	Hader Metal Housings (50-Pack)
0101753-6	Hader White Riders - Reduced (6-Pack)
0101753-24	Hader White Riders - Reduced (24-Pack)
0101753-50	Hader White Riders - Reduced (50-Pack)
0101752-6	Hader Yellow Riders - Standard (6-Pack)
0101752-24	Hader Yellow Riders - Standard (24-Pack)
0101752-50	Hader Yellow Riders - Standard (50-Pack)



0101754

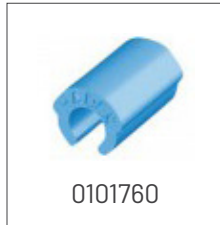

0101760



0101755

Hader Bar	
Item #	Product
0101754-6	Hader Red Riders - Increased (6-Pack)
0101754-24	Hader Red Riders - Increased (24-Pack)
0101754-50	Hader Red Riders - Increased (50-Pack)
0101760-6	Hader Blue Riders - Worn Bars (6-Pack)
0101760-24	Hader Blue Riders - Worn Bars (24-Pack)
0101760-50	Hader Blue Riders - Worn Bars (50-Pack)
0101755	Hader Combo Pack - (2) white riders, (2) yellow riders, (2) red riders

**Ackermann Clips:** Metal Riders provide both rotational and vertical movement with a choice of two styles of acrylic retentions

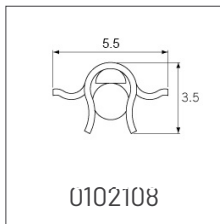

0102108

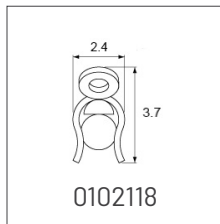

0102118

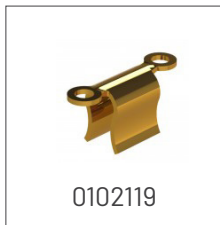

0102119

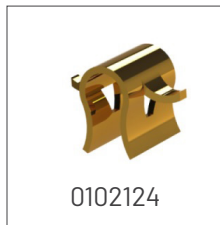

0102124

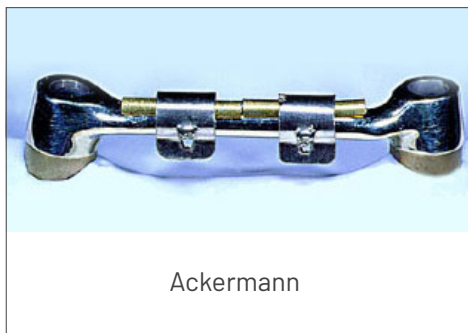

Ackermann

Metal Riders for Hader/Round Bars	
Item #	Product
0102108	Ackermann BL Clip SS
0102108-6	Ackermann BL Clip SS (6-Pack)
0102118	Ackermann MD Clip SS
0102118-6	Ackermann MD Clip SS (6-Pack)
0102119	Ackermann MD Clip GOLD
0102119-6	Ackermann MD Clip GOLD (6-Pack)
0102124	Ackermann BL Clip GOLD
0102124-6	Ackermann BL Clip GOLD (6-Pack)

## UNIVERSAL PLUNGER LOC ATTACHMENT

Titanium locking pin attachment designed for resilient or rigid retention on implant overdenture bars.

- » Biocompatible Titanium
- » Simple to Service
- » Standard Techniques

One universal size may be adjusted from 7.5mm to 4mm in length.

The 1.5mm diameter plunger is compatible with the Low Passive and Swiss Loc NG attachment systems.

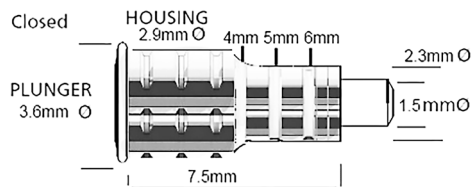

**Plunger Loc:** titanium locking plunger for Overdenture Bars. May be rigid or resilient. 7.5mm long, may be cut to 6, 5, or 4mm. 1.5mm Ø plunger Plunger Diameter compatible with Swiss-Loc & Low Passive



Plunger Loc

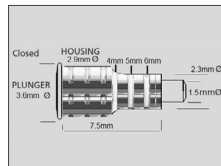

Plunger Loc



1776000



Plunger Loc

### Universal Plunger Loc Attachment

Item #	Product
1776000	Universal Plunger Loc Attachment
1776005	Universal Plunger Loc Processing Jig
1776010	Universal Plunger Loc Male Only
1776015	Universal Plunger Loc Twist Drill
1776030	Universal Plunger Loc Delrin Inserts

**Sphero Reconstruction Kits:** designed to salvage and restore worn mini-implants, direct placement or post coping balls, Sagital Balls (like Bredent VKS and Sagix) and o-ring attachments



Reconstruction Kit



Reconstruction Kit



0800266

Concave Sphere Retrofit Kits	
Item #	Product
0800142	Sphero Reconstruction Kit 1.8mm Ø 2.7mm* vertical, 4.3mm Ø, 2 hollow TiN spheres, 1 strip holder, 2 pink females, 1 insertion tool
0800280	1.8mm Stainless Cap Housing (2-Pack)
0800144	Sphero Reconstruction Kit 2.2mm 2.7mm* vertical, 4.3mm Ø, 2 hollow TiN spheres, 1 strip holder, 2 pink females, 1 insertion tool
0800146	Sphero Reconstruction Kit 2.5mm Ø 2.7mm* vertical, 4.8mm Ø, 2 hollow TiN spheres, 1 strip holder, 2 pink females, 1 insertion tool
0800180	2.5mm Stainless Cap Housing (2-Pack)
0800266	1.8mm Retention Caps, White (6-Pack)

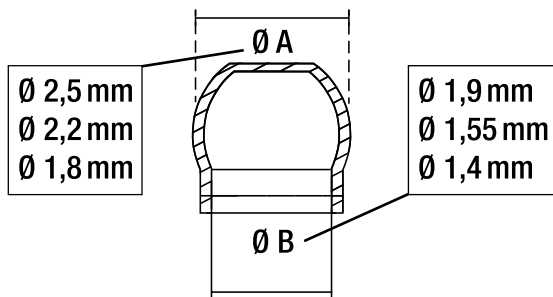

# Experience PreatLoc™

## The Next Generation in Overdenture Attachments

Backed by 45 years of Preat overdenture expertise and trusted support, **PreatLoc™** delivers reliable performance for your practice and lasting smiles for your patients.



### The PreatLoc™ Advantage

**Compatible:** PreatLoc™ is compatible with the leading overdenture attachment system and all major implant systems.

**Tissue-Friendly:** The tissue-friendly ZrN coating is designed for comfort and cleanliness, reducing biofilm, plaque adhesion and inflammation.

**Reliable Retention:** PreatLoc™ retention inserts have demonstrated reliable lifetime performance over 5,000 cycles and have strict tolerance parameters to ensure they deliver the stated retention force.<sup>1</sup>

**Treatment Flexibility:** Our 18° angled abutments address up to 76° divergence, helping maintain balanced load distribution for less insert wear and greater patient comfort.

### PreatLoc™ ZrN Tissue-Friendly Surface Promotes Long-Term Success

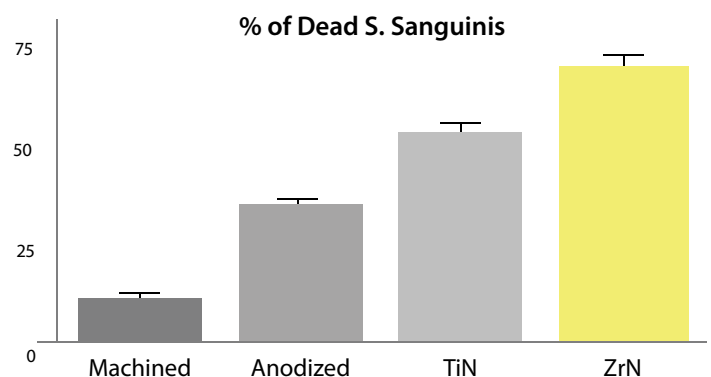

- Biocompatible surface with reduced plaque adhesion<sup>1,2</sup>
- Shows greater bacterial resistance than TiN<sup>2</sup>

1. Chih-Ho Lai, Yin-Yu Chang, Heng-Li Huang, Ho-Yi Kao. Characterization and antibacterial performance of ZrCN/amorphous carbon coatings deposited on titanium implants. Available online 25 June 2011  
2. Brunello G, Brun P, Gardin C, Ferroni L, Bressan E, Meneghello R, et al. (2018) Biocompatibility and antibacterial properties of zirconium nitride coating on titanium abutments: An in vitro study. PLoS ONE 13(6): e0199591. <https://doi.org/10.1371/journal.pone.0199591>

Explore  
**PreatLoc™**  
Solutions



## SYSTEM OVERVIEW

PreatLoc™ is a complete overdenture attachment system designed for reliable performance and seamless integration.

### Tissue-Friendly ZrN Coating

- Biocompatible surface with reduced plaque adhesion<sup>1,2</sup>
- Has shown greater bacterial resistance than TiN<sup>2</sup>

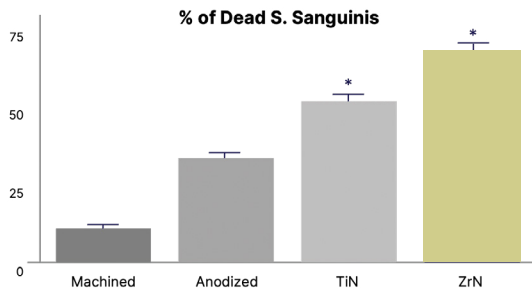

### Reliable Retention

- Standard pivot inserts accommodate up to 20° divergence
- Extended pivot inserts for up to 40° divergence
- Demonstrated reliable and long-lasting performance<sup>3</sup>

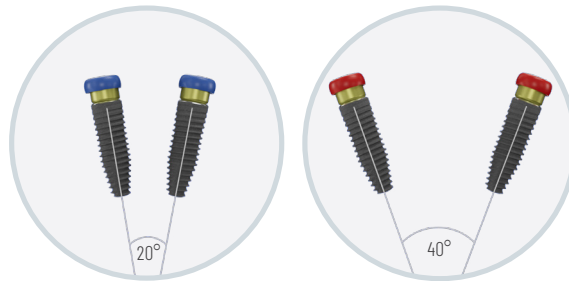

### Anodized Aesthetic Denture Cap

- Enhances aesthetics in thin acrylic for an improved appearance without compromising prosthesis contours



### Treatment Flexibility

- 18° angled abutments improve abutment parallelism, load distribution and insert performance
- When used with extended pivot inserts, PreatLoc™ angled abutments accommodate up to 76° of implant divergence.

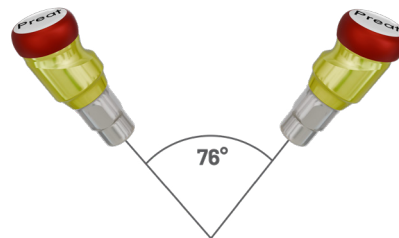

### Highly Compatible. Zero Learning Curve

- Compatible with the leading overdenture attachment system
- Compatible with all major implant systems, including NobelActive™, Straumann® Bone Level, ZimVie Tapered Screw-Vent® and more.

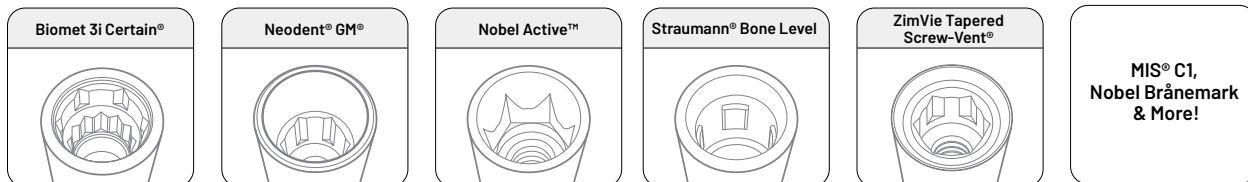

1. Chih-Ho Lai a, Yin-Yu Chang b, Heng-Li Huang c, Ho-Yi Kao Characterization and antibacterial performance of ZrN/amorphous carbon coatings deposited on titanium implants Available online 25 June 2011

2. Brunello G, Brun P, Gardin C, Ferroni L, Bressan E, Meneghello R, et al. (2018) Biocompatibility and antibacterial properties of zirconium nitride coating on titanium abutments: An in vitro study. PLoS ONE 13(6): e0198591. <https://doi.org/10.1371/journal.pone.0198591>

3. Internal data on file

©2025 Copyright Preat Corporation • All rights reserved • Specifications are subject to change without notice. All product names, logos, and brands are property of their respective owners. All company, product and service names are for identification purposes only. Use of these third-party names, logos, and brands does not imply, nor should it be understood as, any indication that the respective third-party brand owners have endorsed or sponsored, or are otherwise affiliated with or connected to, Preat or Preat's goods or services.

## SPECIFICATIONS

### PreatLoc™ Retention Inserts

16

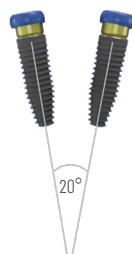
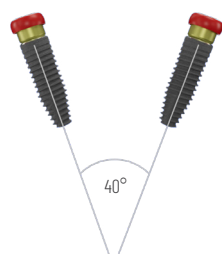
<p><b>Standard Pivot with Dual Retention</b> For use with two or more abutments. Accommodates up to 20° divergence.</p> 			<p><b>Try-In</b> For denture try-ins and protection. Not for long-term use.</p>	<p><b>Extended Range</b> For use with angled abutments and when implant divergence is greater than 20°. Accommodates up to 40° divergence.</p> 		
clear <b>strong</b> retention 5 lbs	pink <b>medium</b> retention 3 lbs	blue <b>light</b> retention 1.5 lbs	gray zero retention 0 lbs	red <b>light</b> retention 1 lb	orange <b>medium</b> retention 2 lbs	green <b>strong</b> retention 4 lbs

The selection of the retention insert depends on the individually desired strength of the anchorage or retention.

Always start with the inserts with the least retention!

## Dimensional Specifications: Abutment and Denture Cap

### PREATLOC™ ABUTMENTS

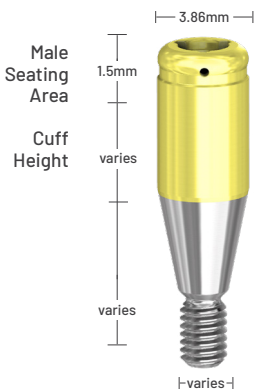

Cuff height, thread diameter and thread length vary by implant system

### PREATLOC™ BAR ABUTMENT

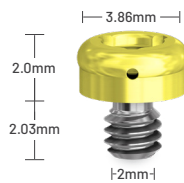

### ABUTMENT FOR MULTI-UNIT

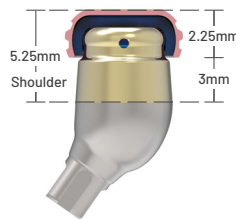

### DENTURE CAP

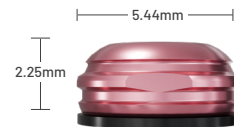

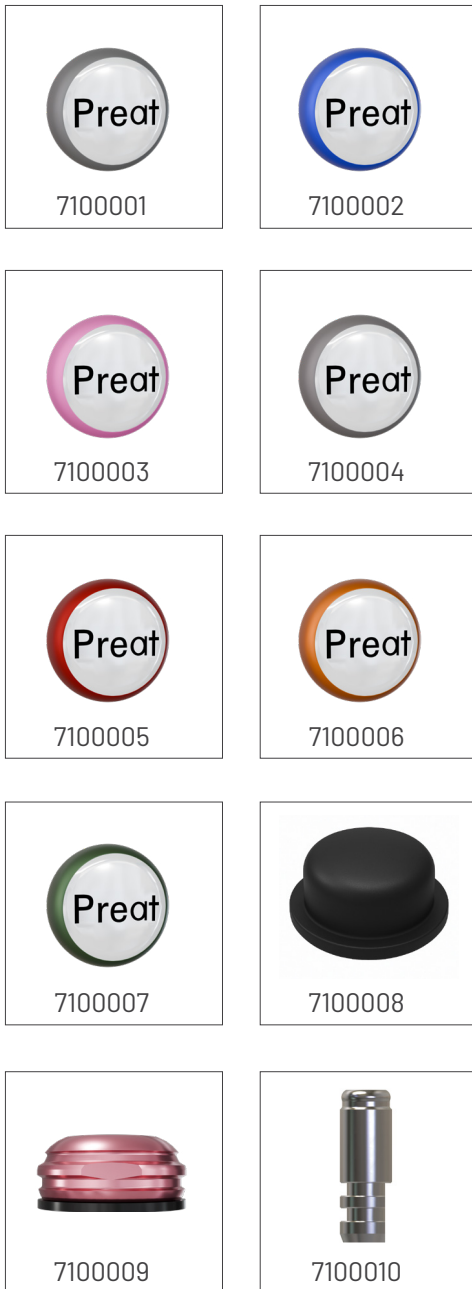

PREATLOC™ ACCESSORIES	
Item #	Product
7100001-4	PreatLoc™ Gray Replacement Insert, 4 Pack
7100001-20	PreatLoc™ Gray Replacement Inser, 20 Pack
7100002-4	PreatLoc™ Blue Replacement Insert, 4 Pack
7100002-20	PreatLoc™ Blue Replacement Insert, 20 Pack
7100003-4	PreatLoc™ Pink Replacement Insert, 4 Pack
7100003-20	PreatLoc™ Pink Replacement Insert, 20 Pack
7100004-4	PreatLoc™ Clear Replacement Insert, 4 Pack
7100004-20	PreatLoc™ Clear Replacement Insert, 20 Pack
7100005-4	PreatLoc™ Red Replacement Insert, 4 Pack
7100005-20	PreatLoc™ Red Replacement Insert, 20 Pack
7100006-4	PreatLoc™ Orange Replacement Insert, 4 Pack
7100006-20	PreatLoc™ Orange Replacement Insert, 20 Pack
7100007-4	PreatLoc™ Green Replacement Insert, 4 Pack
7100007-20	PreatLoc™ Green Replacement Insert, 20 Pack
7100008-4	PreatLoc™ Black Processing Insert, 4 Pack
7100008-20	PreatLoc™ Black Processing Insert, 20 Pack
7100009-4	PreatLoc™ Cap Assembly - Anodized Cap, 4 pack
7100009-10	PreatLoc™ Cap Assembly - Anodized Cap, 10 Pack
7100010-4	PreatLoc™ 4mm Lab Analog, 4 Pack
7100010-20	PreatLoc™ 4mm Lab Analog, 20 Pack
7100022-4	PreatLoc™ Angled Abutment Analog (4mm Diameter) ,4 Pack

# ATTACHMENTS

## OVERDENTURE STUD

18



### PREATLOC™ ACCESSORIES

Item #	Product
7100011-4	PreatLoc™ Impression Coping, 4 Pack
7100011-20	PreatLoc™ Impression Coping, 20 Pack
7100012-4	PreatLoc™ Yellow Processing Insert for Bar, 4 Pack
7100012-20	PreatLoc™ Yellow Processing Insert for Bar, 20 Pack
7100013	PreatLoc™ Universal Instrument 4-piece with PEEK Abutment Holder Sleeve
7100014	PreatLoc™ Abutment Driver for Latch Handpiece with PEEK Abutment Holder Sleeve
7100015-2	PreatLoc™ Standard Pivot Processing Pack Assembly - Anodized Cap, 2 Pack
7100015-10	PreatLoc™ Standard Pivot Processing Pack Assembly - Anodized Cap, 10 Pack
7100016-2	PreatLoc™ Extended Pivot Processing Pack Assembly - Anodized Cap, 2 Pack
7100016-10	PreatLoc™ Extended Pivot Processing Pack Assembly - Anodized Cap, 10 Pack
7100017-2	PreatLoc™ Processing Pack for Bar - Anodized Cap, 2 Pack
7100017-10	PreatLoc™ Processing Pack for Bar - Anodized Cap, 10 Pack
7100018-2	PreatLoc™ Abutment for Bar, 2.0mm Thread, 2 Pack
7100018-10	PreatLoc™ Abutment for Bar, 2.0mm Thread, 10 Pack
7100019-20	PreatLoc™ Block-Out Spacer, 20 Pack
7100020-4	PreatLoc™ Processing Spacer, 4 Pack
7100020-20	PreatLoc™ Processing Spacer, 20 Pack
7100021-4	PreatLoc™ Parallel Post, 4 Pack

### STRAIGHT ABUTMENTS

#### PREATLOC™ ABUTMENT TISSUE CUFF HEIGHT

IMPLANT ABUTMENT DESCRIPTION	0.0MM	0.75MM	1.0MM	2.0MM	3.0MM	4.0MM	5.0MM	6.0MM
<b>BIOHORIZONS®</b>								
Tapered Internal 3.0mm			710521	710522	710523	710524	710525	710526
Tapered Internal 3.5mm	710540		710541	710542 (2.5mm)	710543 (3.5mm)	710544 (4.5mm)	710545 (5.5mm)	
Tapered Internal 4.5mm	710550		710551	710552	710553	710554	710555	
Tapered Internal 5.7mm			710561	710562	710563	710564	710565	
<b>BIOMET 3I®</b>								
Certain 3.4mm			710161	710162	710163	710164	710165	
Certain 4.1mm			710171 (0.73mm)	710172	710173	710174	710175	
<b>DENTSPLY SIRONA®</b>								
Ankylos™ C/X (Conical Connection)				710482	710483	710484		
Astra™ Aqua			710211	710212	710213	710214		
Astra™ Lilac	710221 (0.5mm)			710222	710223	710224	710225	
Astra™ EV 3.6mm			710651	710652	710653	710654		
Astra™ EV 4.2mm			710661	710662	710663	710664	710665	
Astra™ EV 4.8mm			710671	710672	710673	710674	710675	
MIS® C1 NP			710741	710742	710743	710744		
MIS® C1 SP			710751	710752	710753	710754		
<b>HIOSSSEN™</b>								
Mini			710501	710502	710503	710504	710505	710506
Regular (Standard)			710511	710512	710513	710514	710515	710516
<b>KEYSTONE®</b>								
TiLobe™ 3.5mm				710572		710574		
TiLobe™ 4.1mm				710582		710584		
TiLobe™ 5.0mm				710592		710594		
<b>MEGAGEN®</b>								
AnyRidge™			710441	710442	710443	710444	710445	710446
<b>NEODENT®</b>								
Grand Morse®			710711	710712	710713	710714	710715	710716
<b>NOBELBIOCARE™/NOBEL BRÄNEMARK</b>								
Brånemark RP		710101		710102	710103	710104	710105	710106
NobelBiocare™ Tri-Lobe NP			710041	710042	710043	710044	710045	
NobelBiocare™ Tri-Lobe RP			710051	710052	710053	710054	710055	710056
NobelActive™/Conical 3.0mm			710471	710472	710473	710474	710475	710476
NobelActive™/Conical NP			710081	710082	710083	710084	710085	710086
NobelActive™/Conical RP			710091	710092	710093	710094	710095	710096
<b>STRAUMANN®</b>								
Bone Level NC			710151	710152	710153	710154	710155	710156
Bone Level RC			710141	710142	710143	710144	710145	710146
BLX RB/WB			710701	710702	710703	710704	710705	710706
Tissue Level RN			710121	710122	710123			
<b>ZIMVIE®</b>								
Tapered Screw-Vent® 3.5mm	710010		710011	710012 (2.5mm)	710013 (3.5mm)	710014 (4.5mm)	710015 (5.5mm)	710016 (6.5mm)
Tapered Screw-Vent® 4.5mm	710020		710021	710022 (2.5mm)	710023 (3.5mm)	710024 (4.5mm)	710025 (5.5mm)	
Tapered Screw-Vent® 5.7mm			710031	710032 (2.5mm)	710033 (3.5mm)	710034 (4.5mm)		

©2025 Copyright Preat Corporation • All rights reserved • Specifications are subject to change without notice. All product names, logos, and brands are property of their respective owners. All company, product and service names are for identification purposes only. Use of these third-party names, logos, and brands does not imply, nor should it be understood as, any indication that the respective third-party brand owners have endorsed or sponsored, or are otherwise affiliated with or connected to, Preat or Preat's goods or services.

# ATTACHMENTS

## OVERDENTURE STUD

20

### 18° ANGLED ABUTMENTS

### PREATLOC™ ABUTMENT TISSUE CUFF HEIGHT

IMPLANT ABUTMENT DESCRIPTION	0.75MM	1.0MM	2.0MM	3.0MM	4.0MM	5.0MM
<b>BIOHORIZONS®</b>						
Tapered Internal 3.5mm		710541-18	710542-18	710543-18	710544-18	710545-18
Tapered Internal 4.5mm		710551-18	710552-18	710553-18	710554-18	710555-18
<b>BIOMET 3I®</b>						
Certain 3.4mm		710161-18	710162-18	710163-18	710164-18	710165-18
Certain 4.1mm		710171-18	710172-18	710173-18	710174-18	710175-18
<b>DENTSPLY SIRONA®</b>						
EV 3.6mm			710652-18	710653-18	710654-18	710655-18
EV 4.2mm			710662-18	710663-18	710664-18	
EV 4.8mm			710672-18	710673-18	710674-18	
<b>HIOSSEN™</b>						
Mini		710501-18	710502-18	710503-18	710504-18	710505-18
Regular (Standard)		710511-18	710512-18	710513-18	710514-18	710515-18
<b>MEGAGEN®</b>						
AnyRidge™		710441-18 (1.5mm)		710443-18		710445-18 (4.5mm)
<b>NEODENT™</b>						
Grand Morse		710711-18	710712-18	710713-18	710714-18	710715-18
<b>NOBELBIOCARE™/ NOBEL BRÅNEMARK</b>						
Brånemark RP		710101-18		710103-18		710105-18
NobelBiocare™ Tri-Lobe NP		710041-18		710043-18		710045-18
NobelBiocare™ Tri-Lobe RP		710051-18		710053-18		710055-18
NobelActive™/Conical NP		710081-18	710082-18	710083-18	710084-18	710085-18
NobelActive™/Conical RP		710091-18	710092-18	710093-18	710094-18	710095-18
<b>STRAUMANN™</b>						
Bone Level NC		710151-18	710152-18	710153-18	710154-18	710155-18
Bone Level RC		710141-18	710142-18	710143-18	710144-18	710145-18
BLX RB/WB		710701-18	710702-18	710703-18	710704-18	710705-18
Tissue Level RN		710121-18	710122-18	710123-18		
<b>ZIMMER®</b>						
Tapered Screw Vent 3.5mm		710011-18	710012-18	710013-18	710014-18	710015-18
Tapered Screw Vent 4.5mm		710021-18	710022-18	710023-18	710024-18	710025-18

To determine the correct size O-ring needed, measure the retention zone (red line) – or the area on the male post where the O-ring seats. Select the O-ring from the size chart with the closest matching internal diameter to assure proper fit. The O-ring Combo pack is a great option as well.

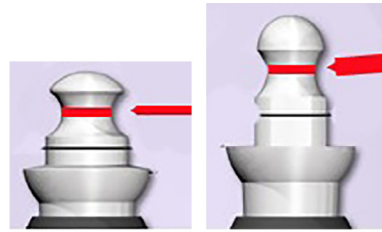
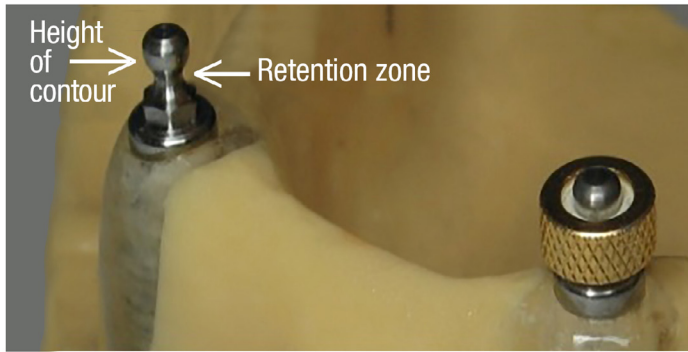

		Size	Internal Diameter (mm)	Outside Diameter (mm)	Corresponding Metal Retainer (aka ring)
	Black #2 (12-Pack 1500603)	Micro	1.00mm	3.6mm	Metal Retainer #2 (1500602), Closed Metal Housing #2 MH-2 (1500601)
	Black #2M (12-Pack 1500197)	1.8 Mini Implant	1.20mm	3.60mm	
	White #3 (12-Pack 1500504)	Standard	1.40mm	4.50mm	Metal Retainer #3 (1500502). For Mini Implants Only: Closed Metal Housing MH-1 (1500501)
	Black #3 (12-Pack 1500503)	Standard	1.40mm	4.50mm	
	Black #4 (6-Pack 1500194)	Large	2.00mm	5.20mm	Metal Retainer #4 (1500204)
	Black #5 (6-Pack 1500195)	Extra Large	2.40mm	6.25mm	Metal Retainer #5 (1500205)
	Combo Pack (10-Pack 1500200)	Micro (2) 1.8 Mini Implant (2) Standard (2) Large (2) Extra Large (2)	2 of each size (Black)		See above
	J-Ring Servicing Kit 1500202)	Micro (2) 1.8 Mini Implant (2) Standard (2) Large (2) Extra Large (2) Insertion Tool (1)	2 of each size (Black) Insertion Tool		See above

# ATTACHMENTS

## OVERDENTURE STUD

**O-Ring Attachment:** features simple techniques, low cost, versatility, and is the most resilient option to protect weaker abutments 3.20mm tall 3.00mm Ø tooth surface 4.50mm Ø housing



O-Ring

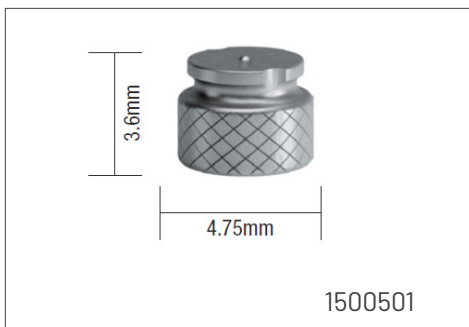
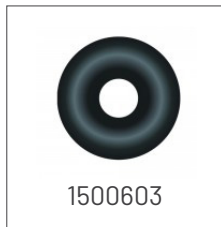
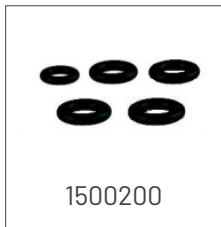

### O-Ring Attachment

Item #	Product
1500200	O-Ring Black O-Ring Combo Pack (10-Pack) 2 of each size of O-Ring (10 total): #2, #2M, #3, #4, and #5
4008049	O-Ring Insertion Tool
1500202	O-Ring Servicing Kit O-Ring Combo pack plus O-Ring Insertion Tool
1500632	O-Ring Overdenture Complete #2 w/ housing 1 Castable Male, 3 black final rings, 1 yellow processing ring, 1 metal retainer ring, 1 processing analog
1500630	O-Ring Castable Male #2 Micro
1500602	O-Ring Metal Retainer #2 & 2M
1500501	O-Ring Closed Metal Housing MH-1
1500601	O-Ring Closed Metal Housing #2 MH-2
1500605	O-Ring Yellow Processing #2 Micro (12-Pack)
1500603	O-Ring Black Rings #2 Micro (12-Pack)
1500606	O-Ring Overdenture Analog #2 Micro



1500502



1500505

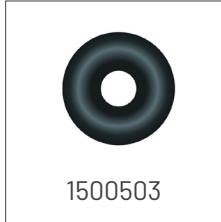

1500503



1500504



1500506



1600025

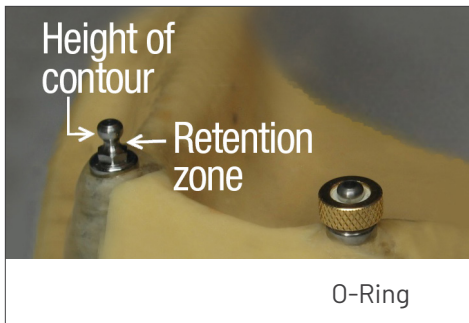

### O-Ring Attachment

Item #	Product
1500197	O-Ring Black Rings #2M (12-Pack)
1500532	O-Ring Overdenture Complete #3 w/ housing 1 Castable Male, 3 white final rings, 1 red processing ring, 1 metal retainer ring, 1 processing analog
1500530	O-Ring Castable Male Standard #3
1500502	O-Ring Metal Retainer Standard #3
1500505	O-Ring Red Processing Rings #3 (12-Pack)
1500503	O-Ring Black Rings Standard #3 (12-Pack)
1500504	O-Ring White Rings Standard #3 (12-Pack)
1500506	O-Ring Overdenture Analog Standard #3
1600025	O-Ring Implant Analog
1500204	O-Ring Metal Retainer #4
1500194	O-Ring Black Rings #4 (6-Pack)
1500214	O-Ring Overdenture Analog #4
1500205	O-Ring Metal Retainer #5
1500195	O-Ring Black Rings #5 (6-Pack)

**O-Ring Mini Implant Attachment:** compatible with mini implant systems featuring a square base and 1.8mm ball top.



1500610



1500212

### O-Ring Mini Implant Attachment

Item #	Product
1500610	O-Ring Mini Implant Servicing Kit 1 impression coping, 1 model analog, 1 MH-2 closed housing, 1 yellow processing O-ring, 2 black O-rings
1500212	O-Ring Mini Implant Impression Copings
1500210	O-Ring Mini Implant Analog #2M

# ATTACHMENTS

## IMPLANT ABUTMENTS/ATTACHMENTS

**O-Ring Attachment:** the extremely resilient titanium O-Ring attachment requires 4.0mm vertical, 5.0mm Ø All abutments include metal retainer ring, 1 red processing ring, and 3 black rubber rings

24

O-Ring Abutment

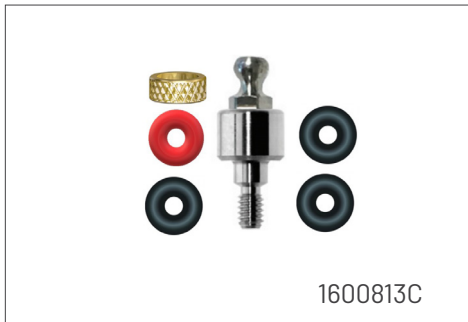
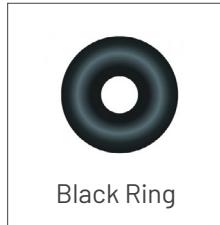
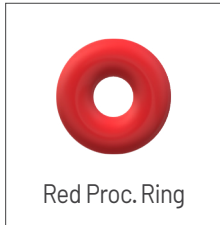

### O-Ring Abutment

Item #	Product
1600801C	O-Ring Abutment Zimmer TSV 3.5 X 1mm
1600802C	O-Ring Abutment Zimmer TSV 3.5 X 2mm
1600803C	O-Ring Abutment Zimmer TSV 3.5 X 3mm
1600804C	O-Ring Abutment Zimmer TSV 3.5 X 4mm
1600805C	O-Ring Abutment Zimmer TSV 3.5 X 5mm
1600806C	O-Ring Abutment Zimmer TSV 3.5 X 6mm
1600811C	O-Ring Abutment Zimmer TSV 4.5 X .5mm
1600812C	O-Ring Abutment Zimmer TSV 4.5 X 2mm
1600813C	O-Ring Abutment Zimmer TSV 4.5 X 3mm
1600814C	O-Ring Abutment Zimmer TSV 4.5 X 4mm
1600815C	O-Ring Abutment Zimmer TSV 4.5 X 5mm
1600816C	O-Ring Abutment Zimmer TSV 4.5 X 6mm
1600821C	O-Ring Abutment Branemark RP x 1mm
1600822C	O-Ring Abutment Branemark RP x 2mm
1600823C	O-Ring Abutment Branemark RP x 3mm

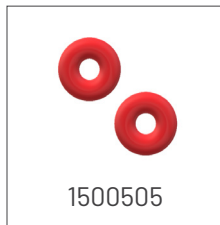

### O-Ring Abutment

Item #	Product
1600824C	O-Ring Abutment Branemark RP x 4mm
1600825C	O-Ring Abutment Branemark RP x 5mm
1600826C	O-Ring Abutment Branemark RP x 6mm
1500502	O-Ring Metal Retainer Standard #3 (each)
1500505	O-Ring Red Processing Rings #3 (12-Pack)
1500503	O-Ring Black Rings Standard #3 (12-Pack)
1500504	O-Ring White Rings Standard #3 (12-Pack)
1600025	O-Ring Implant Analog
1600030	O-Ring/Clix Latch Driver
1600035	Latch to Square Driver Insert
4008049	O-Ring Insertion Tool

# ATTACHMENTS

## IMPLANT ABUTMENTS/ATTACHMENTS

**Clix® Attachment:** 2.25mm spherical attachment with slotted plastic female to engage a larger surface area of the sphere and reduce wear. This unique female makes an audible click to ensure prosthesis security. Housing may be paralleled to correct up to 30° divergence requires: 4.0mm vertical, 4.0mm Ø

26

Clix®



### Clix®

Item #	Product
1608001C	Clix Complete Ball Abutment for Nobel Active NP x 1mm
1608002C	Clix Complete Ball Abutment for Nobel Active NP x 2mm
1608003C	Clix Complete Ball Abutment for Nobel Active NP x 3mm
1608004C	Clix Complete Ball Abutment for Nobel Active NP x 4mm
1608005C	Clix Complete Ball Abutment for Nobel Active NP x 5mm
1608006C	Clix Complete Ball Abutment for Nobel Active NP x 6mm
1600901C	Clix Complete Ball Abutment for Nobel Active RP x 1mm
1600902C	Clix Complete Ball Abutment for Nobel Active RP x 2mm
1600903C	Clix Complete Ball Abutment for Nobel Active RP x 3mm
1600904C	Clix Complete Ball Abutment for Nobel Active RP x 4mm
1600905C	Clix Complete Ball Abutment for Nobel Active RP x 5mm
1600906C	Clix Complete Ball Abutment for Nobel Active RP x 6mm
1601500C	Clix Complete Ball Abutment for Straumann Bone Level NC x 1mm
1601501C	Clix Complete Ball Abutment for Straumann Bone Level NC x 2mm

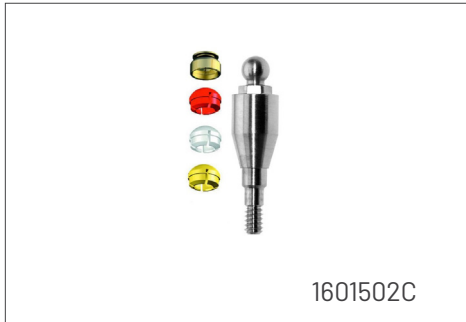

Cliv <sup>®</sup>	
Item #	Product
1601502C	Cliv Complete Ball Abutment for Straumann Bone Level NC x 3mm
1601503C	Cliv Complete Ball Abutment for Straumann Bone Level NC x 4mm
1601504C	Cliv Complete Ball Abutment for Straumann Bone Level NC x 5mm
1601505C	Cliv Complete Ball Abutment for Straumann Bone Level NC x 6mm
1601400C	Cliv Complete Ball Abutment for Straumann Bone Level RC x 1mm
1601401C	Cliv Complete Ball Abutment for Straumann Bone Level RC x 2mm
1601402C	Cliv Complete Ball Abutment for Straumann Bone Level RC x 3mm
1601403C	Cliv Complete Ball Abutment for Straumann Bone Level RC x 4mm
1601404C	Cliv Complete Ball Abutment for Straumann Bone Level RC x 5mm
1601405C	Cliv Complete Ball Abutment for Straumann Bone Level RC x 6mm
1600100C	Cliv Complete Ball Abutment for Zimmer TSV NP x 1mm
1600102C	Cliv Complete Ball Abutment for Zimmer TSV NP x 2mm
1600103C	Cliv Complete Ball Abutment for Zimmer TSV NP x 3mm
1600104C	Cliv Complete Ball Abutment for Zimmer TSV NP x 4mm
1600105C	Cliv Complete Ball Abutment for Zimmer TSV NP x 5mm
1600106C	Cliv Complete Ball Abutment for Zimmer TSV NP x 6mm

# ATTACHMENTS

## IMPLANT ABUTMENTS/ATTACHMENTS

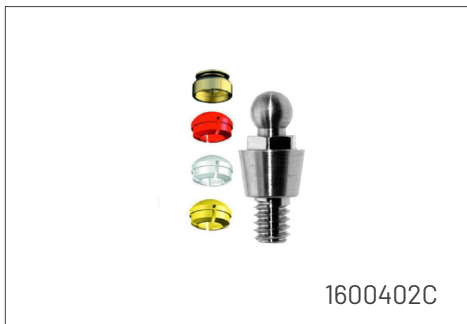

28

Clix®

**Clix®**

Item #	Product
1600200C	Clix Complete Ball Abutment for Zimmer TSV RP x 1mm
1600202C	Clix Complete Ball Abutment for Zimmer TSV RP x 2mm
1600203C	Clix Complete Ball Abutment for Zimmer TSV RP x 3mm
1600204C	Clix Complete Ball Abutment for Zimmer TSV RP x 4mm
1600205C	Clix Complete Ball Abutment for Zimmer TSV RP x 5mm
1600206C	Clix Complete Ball Abutment for Zimmer TSV RP x 6mm
1600402C	Clix Complete Ball Abutment for Tri-Lobe NP x 2mm
1600403C	Clix Complete Ball Abutment for Tri-Lobe NP x 3mm
1600404C	Clix Complete Ball Abutment for Tri-Lobe NP x 4mm
1600405C	Clix Complete Ball Abutment for Tri-Lobe NP x 5mm
1600406C	Clix Complete Ball Abutment for Tri-Lobe NP x 6mm
1600500C	Clix Complete Ball Abutment for Tri-Lobe RP x 0mm



Clix®	
Item #	Product
1600502C	Clix Complete Ball Abutment for Tri-Lobe RP x 2mm
1600503C	Clix Complete Ball Abutment for Tri-Lobe RP x 3mm
1600504C	Clix Complete Ball Abutment for Tri-Lobe RP x 4mm
1600505C	Clix Complete Ball Abutment for Tri-Lobe RP x 5mm
1600506C	Clix Complete Ball Abutment for Tri-Lobe RP x 6mm
1602102C	Clix Complete Ball Abutment for Astra Aqua 3.5/4.0mm x 2mm
1602104C	Clix Complete Ball Abutment for Astra Aqua 3.5/4.0mm x 4mm
1602202C	Clix Complete Ball Abutment for Astra Lilac 4.5/5.0mm x 2mm
1602204C	Clix Complete Ball Abutment for Astra Lilac 4.5/5.0mm x 4mm
1601602C	Clix Complete Ball Abutment for Biomet 3i Certain 3.4mm x 2mm
1601604C	Clix Complete Ball Abutment for Biomet 3i Certain 3.4mm x 4mm
1601702C	Clix Complete Ball Abutment for Biomet 3i Certain 4.1mm x 2mm
1601704C	Clix Complete Ball Abutment for Biomet 3i Certain 4.1mm x 4mm

# ATTACHMENTS

## IMPLANT ABUTMENTS/ATTACHMENTS

30

Clix®

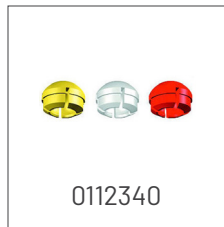
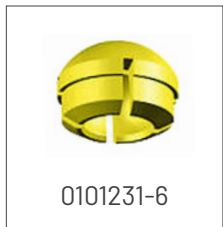
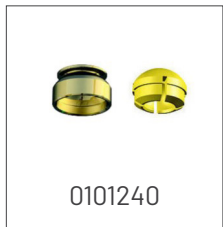

Clix®

Item #	Product
1600303C	Clix Complete Ball Abutment for Straumann RN x 2mm
1600304C	Clix Complete Ball Abutment for Straumann RN x 3mm
1600305C	Clix Complete Ball Abutment for Straumann RN x 4mm
1601002C	Clix Complete Ball Abutment for Neoss 3.5-6.0mm x 2mm
1601004C	Clix Complete Ball Abutment for Neoss 3.5-6.0mm x 4mm
1600020	Clix Implant Ball Analog
1600030	Clix Latch Driver
1600035	Latch to Square Driver Insert
011222	Clix Female Insertion Tool
0101240	Clix Complete Female TI housing and yellow female
0101232W-6	Clix White Females- Reduced (6-Pack) white = 1.7lbs retention
0101232W-50	Clix White Females- Reduced (50-Pack)
0101231-6	Clix Yellow Females- Standard (6-Pack) yellow = 2.5 lbs retention
0101231-50	Clix Yellow Females- Standard (50-Pack)
0101233-6	Clix Red Females- Increased (6-Pack) red = 3.3 lbs retention
0101233-50	Clix Red Females- Increased (50-Pack)
0112340	Clix Combo Females 2 white, 2 yellow, 2 red Clix Females

**LOCATOR®:** the most popular stud attachment in the world due to its angle correction, ease of use, lowprofile 9 different retention levels to meet patient's needs, and patented PIVOT between the housing and nylon male that reduces potential wear on the abutment. \*Beware imitations that do not pivot\* 2.73mm vertical, 5.45mm Ø



LOCATOR

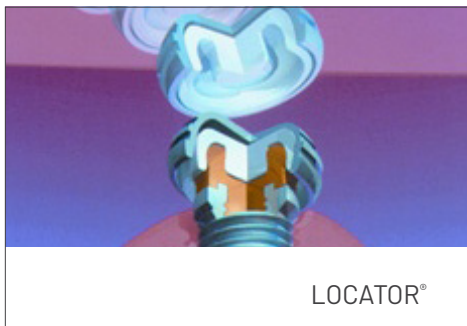

LOCATOR®



4008260



4008913



4008926



4008393

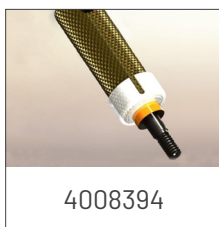

4008394



4008505

### LOCATOR® Self Aligning

Item #	Product
4008260	LOCATOR® 35n Square Driver (15mm) <i>For use with Straumann torque wrenches</i>
4008280	LOCATOR® 35n Square Driver (21mm) <i>For use with Straumann torque wrenches</i>
4008913	LOCATOR® Insert Driver (Latch 23mm)
4008914	LOCATOR® Insert Driver (Latch 29mm)
4008926	LOCATOR® Square Insert Driver (15mm)
4008927	LOCATOR® Square Insert Driver (21mm)
4008393	LOCATOR® Core Tool
4008390	LOCATOR® Gold Driver
4008397	LOCATOR® Male Removal Tool
4008394	LOCATOR® Abutment Carrier (4-Pack)
4009006	LOCATOR® Demo Model
4009014	LOCATOR® Root Model
4009015	LOCATOR® Implant Model w/External Hexed Implants
4008505	LOCATOR® Impression Coping (4-Pack)
4008505-20	LOCATOR® Impression Coping (20-Pack)
4008530	LOCATOR® Female Analog (4.0mm)(4-Pack) <i>The 4mm ȳ analog is for Narrow and Regular Platform Implants</i>
4008530-20	LOCATOR® Female Analog (4.0mm)(20-Pack)
4008514	LOCATOR® Block Out Spacer (20-Pack)
4008515	LOCATOR® Processing Replacement Male (Black)(4-Pack)

# ATTACHMENTS

## IMPLANT ABUTMENTS/ATTACHMENTS

32

LOCATOR® Self Aligning

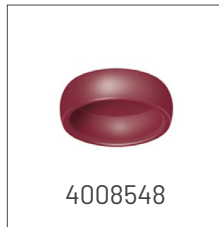

### LOCATOR® Self Aligning

Item #	Product
4008515-20	LOCATOR® Processing Replacement Male (Black) (20-Pack)
4008516	LOCATOR® Female Analog (5.0mm)(4-Pack) <i>The 5mm Ø analog is for Wide Platform Implants &amp; Natural Teeth</i>
4008516-20	LOCATOR® Female Analog (5.0mm)(20-Pack)
4008517	LOCATOR® Parallel Post (4-Pack)
4008524	LOCATOR® Replacement Male (Clear)(4-Pack)
4008524-20	LOCATOR® Replacement Male (Clear)(20-Pack)
4008527	LOCATOR® Light Retention Replacement Male (Pink) (4-Pack)
4008527-20	LOCATOR® Light Retention Replacement Male (Pink) (20-Pack)
4008529	LOCATOR® Extra Light Retention Replacement Male (Blue)(4-Pack)
4008529-20	LOCATOR® Extra Light Retention Replacement Male (Blue)(20-Pack)
4008547	LOCATOR® Extended Range Replacement Male (Green)(4-Pack)
4008547-20	LOCATOR® Extended Range Replacement Male (Green)(20-Pack)
4008548	LOCATOR® Extra Light Retention Extended Range Replacement Male (Red)(4-Pack)
4008548-20	LOCATOR® Extra Light Retention Extended Range Replacement Male (Red)(20-Pack)
4008915	LOCATOR® Extended Range Replacement Male (Orange)(4-Pack)
4008915-20	LOCATOR® Extended Range Replacement Male (Orange)(20-Pack)
4008558	LOCATOR® Zero Retention Extended Range Replacement Male (Gray)(4-Pack)
4008558-20	LOCATOR® Zero Retention Extended Range Replacement Male (Gray)(20-Pack)
4008559	LOCATOR® High Retention Replacement Male (Purple) (4-Pack)
4008026	LOCATOR® Bar Processing Replacement Male (Yellow) (4-Pack)
4008026-20	LOCATOR® Bar Processing Replacement Male (Yellow) (20-Pack)
4008569	LOCATOR® Processing Spacer (4-Pack)

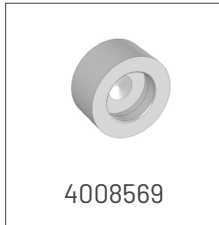

4008569



4008510



4008519



4008540



4008550



4008028



LOCATOR



4008011

### LOCATOR® Self Aligning

Item #	Product
4008569-20	LOCATOR® Processing Spacer (20-Pack)
4008510-4	LOCATOR® Replacement Denture Cap Male Assembly (4-Pack)
4008510-10	LOCATOR® Replacement Denture Cap Male Assembly (10-Pack)
4008519-2	LOCATOR® Male Processing Package (2-Pack)
4008519-10	LOCATOR® Male Processing Package (10-Pack)
4008540-2	LOCATOR® Extended Range Male Processing Package (2-Pack)
4008540-10	LOCATOR® Extended Range Male Processing Package (10-Pack)
4008550-2	LOCATOR® Male Processing Package SS (2-Pack) <i>Stainless Steel housing ideal for welding to CoCr framework, SS housing, blackout spacer, blue / pink / clear males</i>
4008550-10	LOCATOR® Male Processing Package SS (10-Pack)
4008028-2	LOCATOR® Bar Male Processing (2-Pack) <i>T1 housing. w/ yellow, 2 block. spacers, blue / pink / clear</i>
4008028-10	LOCATOR® Bar Male Processing (10-Pack)
4008010	LOCATOR® Refill Kit <i>Four 0° females, 2 parallel posts, 4 complete males</i>
4008011	LOCATOR® Starter Kit <i>Spotface Drill, Pilot Drill, Four 0° females, 4 complete males, 2 parallel posts</i>
4008050	LOCATOR® Refill Coping Kit <i>4 Cast-to females w/parallel posts, 4 complete males</i>
4008051	LOCATOR® Coping Kit <i>Spotface Drill, Pilot Drill, 4 Cast-to females w/parallel posts, 4 complete males</i>
4008070	LOCATOR® Refill Mixed Kit <i>Two 0°, One 10°, One 20° females, 2 parallel posts, 4 complete males</i>

# ATTACHMENTS

## IMPLANT ABUTMENTS/ATTACHMENTS

34

LOCATOR® Self Aligning



### LOCATOR® Self Aligning

Item #	Product
4008071	LOCATOR® Mixed Kit <i>Spotface Drill, Pilot Drill, Two 0°, One 10°, One 20° females, 2 parallel posts, 4 complete males</i>
4008922	LOCATOR® Spotface Diamond Bur
4008924	LOCATOR® Pilot Drill
4008520-2	LOCATOR® 0 Degree Female (2-Pack)
4008520-10	LOCATOR® 0 Degree Female (10-Pack)
4008521-2	LOCATOR® 10 Degree Female (2-Pack)
4001747-2	LOCATOR® Retrofit Kit for Worn ERA Root Attachments (2-Pack) <i>Includes LOCATOR® Retrofit, Parallel Post, Weep Hole Alignment Pin</i>
4008521-10	LOCATOR® 10 Degree Female (10-Pack)
4008522-2	LOCATOR® 20 Degree Female (2-Pack)
4008522-10	LOCATOR® 20 Degree Female (10-Pack)
4008528-2	LOCATOR® 0 Degree Cast-to Female (2-Pack)
4008528-10	LOCATOR® 0 Degree Cast-to Female (10-Pack)
4008586-2	LOCATOR® Cast-To Bar Female (2-Pack)
4008586-10	LOCATOR® Cast-To Bar Female (10-Pack)
4008587-2	LOCATOR® Bar Female 2-56 Thread (2-Pack)
4008587-10	LOCATOR® Bar Female 2-56 Thread (10-Pack)
4008588-2	LOCATOR Laser Bar Female, Titanium (2-Pack)
4008588-10	LOCATOR® Laser Bar Female, Titanium (10-Pack)
4008589-2	LOCATOR® Bar Female, 2.0mm Thread (2-Pack)



### LOCATOR® Self Aligning

Item #	Product
4008589-10	LOCATOR® Bar Female, 2.0mm Thread (10-Pack)
4008590-2	LOCATOR® Laser Bar Female, Stainless Steel (2-Pack)
4008590-10	LOCATOR® Laser Bar Female, Stainless Steel (10-Pack)
4008013	LOCATOR® 2-56 Castable sleeve (10-Pack)
4008014	LOCATOR® 2mm Castable Threaded Inserts (10-Pack)
4008016	LOCATOR® Tap Holder
4009020	30N-cm Torque and Thumb Knob Wrench Kit
4009102	1.7mm Bar Drill (2.0mm Thread)
4009103	1.8mm Bar Drill (2-56 Thread)
4009104	2.0mm Bar Tap (2.0mm Thread)
4009105	LOCATOR® 2-56 Bar Tap (2-56 Thread)
4009107	LOCATOR® Paralleling Mandrel for Bar Female
4008909-2	LOCATOR® for Multi-Unit Abutment TI (2-Pack)
4009260-2	LOCATOR Scan Body (2-Pack)
4009260-4	LOCATOR® Scan-body (4-Pack)
4009260-10	LOCATOR Scan Body (10-Pack)

# ATTACHMENTS

## LOCATOR® RETENTION INSERTS

### Attachments



### Dimensional Specifications

#### LOCATOR® IMPLANT ATTACHMENTS

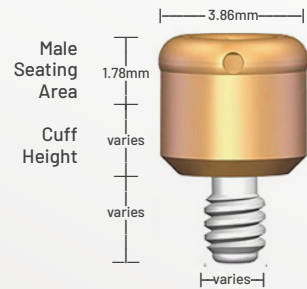

#### LOCATOR® DENTURE CAP & BLACK PROCESSING MALE

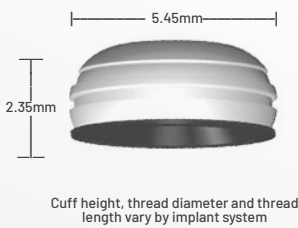

#### LOCATOR® BAR ATTACHMENTS

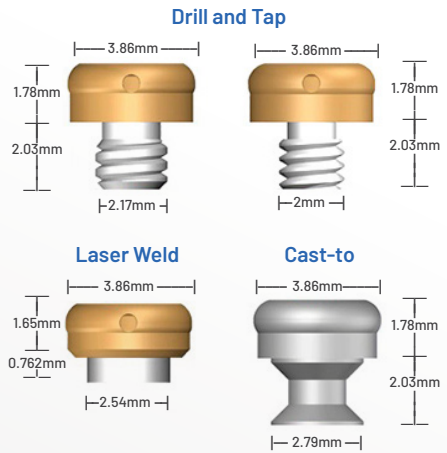

#### LOCATOR® ROOT ATTACHMENTS

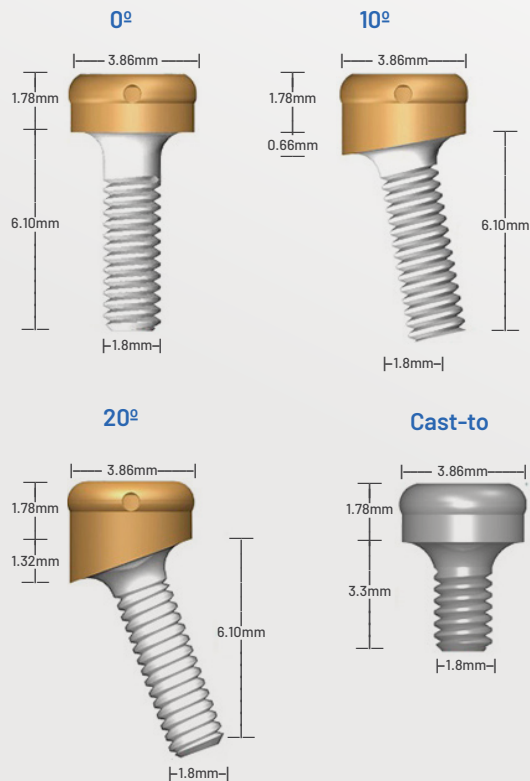

#### LOCATOR® PIVOTING FUNCTION

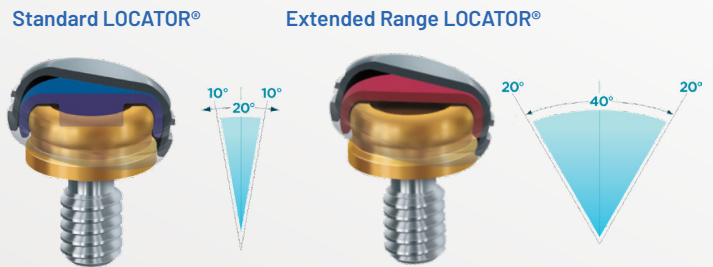

#### LOCATOR® Multi-Unit

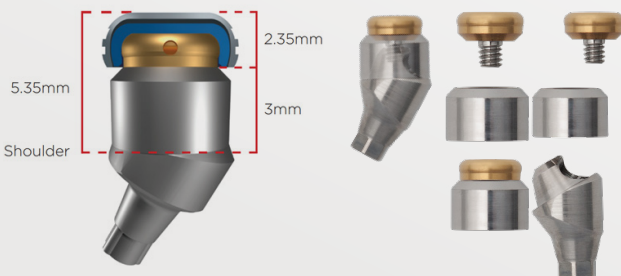

### ABUTMENT TISSUE CUFF HEIGHT

IMPLANT ABUTMENT DESCRIPTION	0.0MM	0.73MM	1.0MM	2.0MM	3.0MM	4.0MM	5.0MM	6.0MM
<b>AB DENTAL®</b>								
3.75mmD (NP)	8661		8662	8663 2.5mm	8664 3.5mm	8665 4.5mm	8625 5.5mm	8626 6.5mm
4.5mmD (WP)	8671		8672	8673	8674	8675	8627	8628
<b>ALMITECH®</b>								
3.3mm/4.1mm/4.8mm	1438		1439	1440	1441	1442	1443	
<b>ALPHA BIO IMPLANT®</b>								
3.5mmD	8661		8662	8663 2.5mm	8664 3.5mm	8665 4.5mm	8625 5.5mm	8626 6.5mm
3.75mmD		1192	1193	1194	1195	1196	1197	1198
<b>ANTHOGYR®</b>								
3.4mm - Short			1697 1.55mm					
3.4mm - Medium				1698 2.5mm				
3.4mm - Tall					1699 3.5mm			
<b>ASTRA®</b>								
TX 3.5mm/4.0mmD			8115	8116	8117	8118	8119	
TX 4.5mm/5.0mmD		8686 0.5mm		8687	8688	8689	8690	
M2 Thread (old style) 3.5mmD		8636 0.81mm		8637	8638	8639	8640	
M2 Thread (old style) 4.0mmD ST		8656 0.5mm		8657	8658	8659	8660	
EV 3.6mmD			2790	2791	2792	2793	2794	
EV 4.2mmD			2795	2796	2797	2798	2799	
EV 4.8mmD			2800	2801	2802	2803	2804	
<b>BICON®</b>								
2.0 Post			8746	8747	8748	8749	8750	
2.5mm			2278	2279	2280	2281	2282	
3.0 Post			8930	8931	8932	8933	8934	
<b>BIOHORIZONS®</b>								
External 3.5mmD (Ex Hex)			8531 1.25mm	8532	8533	8534	8535	
External 4.0mmD (Ex Hex)			8541	8542	8543	8544	8545	
External 5.0mmD (Ex Hex)			8551 1.5mm	8552 2.5mm	8553 3.5mm	8554 4.5mm	8555 5.5mm	
Tapered Internal 3.0mmD			1927	1928	1929	1930		
Tapered Internal 3.5mm/3.8mmD	8661		8662	8663 2.5mm	8664 3.5mm	8665 4.5mm	8625 5.5mm	8626 6.5mm
Tapered Internal 4.0mm/4.5mm/4.6mmD	8671		8672	8673	8674	8675	8627	8628
Tapered Internal 5.7mm/5.8mmD			8190	8191	8192	8193	8194	8195

# ATTACHMENTS

## IMPLANT ABUTMENTS/ATTACHMENTS

### ABUTMENT TISSUE CUFF HEIGHT

IMPLANT ABUTMENT DESCRIPTION	0.0MM	0.73MM	1.0MM	2.0MM	3.0MM	4.0MM	5.0MM	6.0MM
<b>BIOMET 3I®</b>								
Certain® 3.4mmD			8431	8432	8433	8434	8435	8436
Certain® 4.1mmD (Compatible with 5.0mm and 6.0mm)	4.1mm	8630		8631	8632	8633	8634	8635
MicroMiniPlant 3.4mmD (Ex Hex)			8441	8442	8443	8444	8445	8446
MiniPlant 3.75mmD (Ex Hex)		8681		8682	8683	8684	8685	8696
Cylindrical 4.0mm Diameter (Ex Hex)		8681		8682	8683	8684	8685	8696
External 5.0mm Diameter (Ex Hex)		8820 0.6mm		8821	8822	8823	8824	
TG (Internal Connection)			8621 1.25mm	8622 2.25mm	8623 3.25mm	8624 4.25mm		
<b>BIOTECH DENTAL KONTACT®</b>								
			1792		1794		1796	
<b>BLUE SKY BIO®</b>								
Internal Hex 3.7mmD	8661		8662	8663 2.5mm	8664 3.5mm	8665 4.5mm	8625 5.5mm	8626 6.5mm
Internal Hex 4.7mmD	8671		8672	8673	8674	8675	8627	8628
Trilobe 3.5mmD (NP)	8756		8757	8758	8759	8760	8734	8735
Trilobe 4.3mmD (RP)	8761		8762	8763	8764	8765	8753	8754
Trilobe 5.0mmD (WP)			8766	8767	8768	8769	8770	
One Stage Regular		8950		8951	8952	8953	8954	8955
<b>BREIDENT®</b>								
4.1mm			1827	1828	1829	1830	1831	1832
<b>BTI - BIOTECHNOLOGY INSTITUTE SL®</b>								
Internal Hex - 4.1mm			8291	8292	8293	8294	8295	8296
External Hex 4.1mmD		8681		8682	8683	8684	8685	8696
External Hex 5.5mmD				8302	8303	8304	8305	8306
<b>DENTEGRIZ DENTAL TECH®</b>								
3.75mm	8052		8053	8054	8055	8056	8057	
4.5mm		8058 0.63mm		8059	8060	8061	8062	8063
4.8mm Green/Gray/Blue		8950		8951	8952	8953	8954	8955
<b>DENTIUM USA®</b>								
Implantium / Superline 3.4mm/3.8mm, 4.3mm/4.8mm, 4.8mmD		8656 0.5mm		8657	8658	8659	8660	
<b>DENTSPLY / FRIADENT®</b>								
Ankylos® C/X (Conical Connection)				1729	1730	1731	1732	1733
Frialit-2 / Xive 3.4mmD			8805	8806	8807	8808	8809	
Frialit-2 / Xive 3.8mmD			8810	8811	8812	8813	8814	

### ABUTMENT TISSUE CUFF HEIGHT

IMPLANT ABUTMENT DESCRIPTION	0.0MM	0.73MM	1.0MM	2.0MM	3.0MM	4.0MM	5.0MM	6.0MM
<b>DENTSPLY® / FRIADENT® cont'd</b>								
Frialit-2 / Xive 4.5mmD			8815	8816	8817	8818	8819	
Frialit-2 / Xive 5.5mmD			8139 1.3mm	8140	8141	8142	8143	
<b>DIO®</b>								
Dio SM 3.1mm SM (Narrow)			1351	1352	1353	1354	1355	1356
Dio SM 3.5mm (Regular & Wide)			1361	1362	1363	1364	1365	1366
<b>IMTEC®</b>								
Endure® 3.5mm/4.3mm (Internal Hex)		8994 0.63mm		8995	8996	8997	8998	
Self Tapping 3.75mmD (Ex Hex)		8681		8682	8683	8684	8685	8696
Universal 3.4mm/4.0mmD (Ex Hex)		8681		8682	8683	8684	8685	8696
Mini 3.3mmD (Ex Hex)		8856 0.91mm		8857	8858	8859	8860	
<b>IMPLANT DIRECT®</b>								
InterActive / SwishActive™ 3.0mmD (NP)			2069	2070	2071	2072	2073	2074
InterActive / SwishActive™ 3.4mmD (RP)			2075	2076	2077	2078	2079	2080
Legacy™ 3.0mmD (Internal Hex)		2308 0.75mm		2309	2310	2311	2312	2313
Legacy™ 3.5mmD (Internal Hex)	8661		8662	8663 2.5mm	8664 3.5mm	8665 4.5mm	8625 5.5mm	8626 6.5mm
Legacy™ 4.5mmD (Internal Hex)	8671		8672	8673	8674	8675	8627	8628
Legacy™ 5.7mmD (Internal Hex)			1471	1472	1473	1474	1475	1476
RePlus / RePlant / ReActive™ 3.5mmD (Trilobe NP)	8756		8757	8758	8759	8760	8734	8735
RePlus / RePlant / ReActive™ 4.3mmD (Trilobe RP)	8761		8762	8763	8764	8765	8753	8754
RePlus / RePlant / ReActive™ 5.0mmD (Trilobe WP)			8766	8767	8768	8769	8770	
ScrewPlant™ 3.7mmD			1371	1372	1373	1374	1375	1376
ScrewPlant™ 4.7mmD			1381 1.5mm	1382	1383	1384	1385	1386
ScrewPlant™ 5.7mmD				1391	1392	1393	1394	1395
ScrewInDirect™ 5.0mmD				1250	1251	1252	1253	1254
SwishTapered / SwishPlus™ 3.7mmD		1821 0.4mm	1822	1823	1824	1825	1826	
SwishTapered / SwishPlus™ 4.8mmD		8950		8951	8952	8953	8954	8955
<b>IMZ®</b>								
3.3mm/4.0mmD (Ex Hex)		8681		8682	8683	8684	8685	8696
3.3mmD (Non-Hex)	8020		8021	8022	8023	8024	8025	
4.0mmD (Non-Hex)	8030 0.35mm		8031	8032	8033	8034	8035	
<b>INTRA-LOCK SYSTEM INTERNATIONAL®</b>								
Threaded 3.75mm/4.0mmD (Ex Hex)		8681		8682	8683	8684	8685	8696
Threaded Conic 4.3mmD (Ex Hex)			8781	8782	8783	8784	8785	

# ATTACHMENTS

## IMPLANT ABUTMENTS/ATTACHMENTS

### ABUTMENT TISSUE CUFF HEIGHT

IMPLANT ABUTMENT DESCRIPTION	0.0MM	0.73MM	1.0MM	2.0MM	3.0MM	4.0MM	5.0MM	6.0MM
<b>INTRA-LOCK SYSTEM INTERNATIONAL® cont'd</b>								
Threaded 4.75mmD (Ex Hex)			8727 1.42mm	8728	8729	8730	8731	
Threaded Conic 5.0mmD (Ex Hex)			8727 1.42mm	8728	8729	8730	8731	
<b>KEYSTONE® / LIFECORE BIOMEDICAL®</b>								
3.3mm/4.0mmD (Ex Hex)		8681		8682	8683	8684	8685	8696
Stage-1 Regular Diameter		8950		8951	8952	8953	8954	8955
Renova 3.75mmD (Internal Connection)	8090		8091	8092	8093	8094	8095	8096
Revona 4.5mm/4.75mmD (Internal Connection)		8125 0.63mm		8126	8127	8128	8129	8130
Restore SD 3.3mm/3.4mmD (Ex Hex)			8196	8197	8198	8199	8200	
Restore RD 3.75mm/4.0mmD (Ex Hex)		8681		8682	8683	8684	8685	8696
Restore WD 5.0mm/6.0mmD (Ex Hex)			8727 1.42mm	8728	8729	8730	8731	
Sustain 4.2mmD (Ex Hex)		8681		8682	8683	8684	8685	8696
Sustain 4.0mm/4.7mmD	8651		8652	8653	8654	8655		
<b>KYOCERA POI®</b>								
4.2mm (Non-Hexed)		8716 0.35mm	8717	8718-1	8719	8720 4.5mm	8721	
<b>LASAK®</b>								
3.7mm	1207		1208	1209	1210	1211	1212	
<b>MEGAGEN® / INTEGRATED DENTAL SYSTEMS®</b>								
AnyRidge® (Internal Connection)			2100	2101	2102	2103	2104	2105
<b>MIS - MEDICAL IMPLANT SYSTEM®</b>								
Internal Hex 3.75mm/4.2mmD (SP)	8661		8662	8663 2.5mm	8664 3.5mm	8665 4.5mm	8625 5.5mm	8626 6.5mm
Internal Hex 5.0mmD (WP)	8671		8672	8673	8674	8675	8627	8628
External SP (Ex Hex)		8681		8682	8683	8684	8685	8696
External WP (Ex Hex)		8820 0.6mm		8821	8822	8823	8824	
Mistral Internal Octagon (Stage One)		8950		8951	8952	8953	8954	8955
SEVEN 3.3 (Internal Hex 3.3mm NP)	2062 0.1mm		2063	2064	2065	2066	2067	2068
<b>NEOSS®</b>								
4.0mmD (Non-Hex)			8451	8452	8453	8454	8455	8456
<b>NEODENT®</b>								
Cone Morse				2168	2169	2170	2171	2172
Grand Morse			2112	2113	2114	2115	2116	2117
<b>NOBEL BIO CARE® / BRANEMARK® / STERIOSS®</b>								
NobelActive™ / Conical Connection 3.0mmD			2212	2213	2214	2215	2216	2217
NobelActive™ / Conical Connection NP (3.5mmD)			2069	2070	2071	2072	2073	2074
NobelActive™ / Conical Connection RP (4.3mm/5.0mmD)			2075	2076	2077	2078	2079	2080

### ABUTMENT TISSUE CUFF HEIGHT

IMPLANT ABUTMENT DESCRIPTION	0.0MM	0.73MM	1.0MM	2.0MM	3.0MM	4.0MM	5.0MM	6.0MM
<b>NOBEL BIO CARE® / BRANEMARK® / STERIOSS® cont'd</b>								
Steri-Oss Flat-Top 3.8mmD	8651		8652	8653	8654	8655		
Replace Select NP (3.5mmD, Trilobe)	8756		8757	8758	8759	8760	8734	8735
Replace Select RP (4.3mmD, Trilobe)	8761		8762	8763	8764	8765	8753	8754
Replace Select WP (5.0mmD, Trilobe)			8766	8767	8768	8769	8770	
Replace Select 6.0mmD (Trilobe)			8766	8767	8768	8769	8770	
Branemark NP (3.3mmD, Ex Hex)		8105		8106	8107	8108	8109	
Branemark RP (3.75mm/4.0mm/5.0mmD, Ex Hex)		8681		8682	8683	8684	8685	8696
Branemark WP (5.0mmD, Ex Hex)			8825 1.1mm	8826	8827	8828	8829	
Nobel Speedy NP (3.5mmD, Ex Hex)		8105		8106	8107	8108	8109	
Nobel Speedy RP (4.3mmD, Ex Hex)		8681		8682	8683	8684	8685	8696
Replace Ex Hex NP (3.5mmD)			8676	8677	8678	8679	8680	
Replace Ex Hex RP (4.3mmD)			8781	8782	8783	8784	8785	
Replace Ex Hex WP (5.0mmD)			8835 1.37mm	8836	8837	8838	8839	
Hex-Lock (HL) 3.25mmD (Ex Hex)			8646 1.5mm	8647 2.5mm	8648 3.5mm	8649 4.5mm	8650 5.5mm	
Hex-Lock (HL) 3.8mm/4.5mmD (Ex Hex)		8681		8682	8683	8684	8685	8696
Hex-Lock (HL) 5.0mmD (Ex Hex)			8835 1.37mm	8836	8837	8838	8839	
<b>OSSTEM® / HIOSSEN USA® / DENTIS®</b>								
SS Internal / HS Regular 4.8mmD		8950		8951	8952	8953	8954	8955
ET/ HG/ GS Mini 3.5mmD (Internal Connection)			1561	1562	1563	1564	1565	1566
ET/ HG/ GS Regular 4.0mmD (Internal Connection)			1551	1552	1553	1554	1555	1556
US Mini 3.3mm / 3.5mmD (Ex Hex)			8105	8106	8107	8108	8109	
US Regular/ HU Regular 3.75mm / 4.0mmD (Ex Hex)		8681		8682	8683	8684	8685	8696
<b>OSTEO-IMPLANT CORPORATION®</b>								
3.25mm SD, 3.75mm ST, 4.0mm DT		8681		8682	8683	8684	8685	8696
<b>PHIBO® / IMPLADENT®</b>								
TSA S3 - 3.7mm			1755	1756	1757	1758	1759	1760
TSA S4 - 4.7mm			1761 1.4mm	1762	1763	1764	1765	1766
TSA Advanced S5 - 6.0mm				1767	1768	1769	1770	1771
TSH S2 - 3.3mm			1916	1917	1918	1919	1920	1921
TSH S3 & S4 - 4.0mm			1942	1943	1944	1945	1946	1947
TSH S5 - 5.0mm				1922	1923	1924	1925	1926
<b>RIEMSER®</b>								
Arzneimittel Revois - 3.8/4.3/5.0mm			1213	1214	1215	1216	1217	1218
Arzneimittel Revois II - 3.8/4.3/5.0mm	1303 0.2mm		1304	1305	1306	1307	1308	

# ATTACHMENTS

## IMPLANT ABUTMENTS/ATTACHMENTS

### ABUTMENT TISSUE CUFF HEIGHT

IMPLANT ABUTMENT DESCRIPTION	0.0MM	0.73MM	1.0MM	2.0MM	3.0MM	4.0MM	5.0MM	6.0MM
<b>RITTER IMPLANTS®</b>								
Spiral/QSI NP (Internal Hex)		2308 0.75mm		2309	2310	2311	2312	2313
Spiral/QSI RP (Internal Hex)			2284	2285	2286	2287	2288	2289
<b>SOUTHERN IMPLANT USA®</b>								
Tri-Nex 3.5mmD	8756		8757	8758	8759	8760	8734	8735
Tri-Nex 4.3mmD	8761		8762	8763	8764	8765	8753	8754
Tri-Nex 5.0mmD			8766	8767	8768	8769	8770	
Tri-Nex 6.0mmD			8766	8767	8768	8769	8770	
IT 4.8mmD (Internal Octagon)		8950		8951	8952	8953	8954	8955
<b>STERNGOLD IMPLAMED®</b>								
Hex Cylinder 3.3mm/4.0mmD		8681		8682	8683	8684	8685	8696
Hex Screw 3.75mm/4.0mmD		8681		8682	8683	8684	8685	8696
<b>STRAUMANN®</b>								
Tissue Level 3.5mmD (NNC)			2056	2057	2058	2059	2060	2061
Tissue Level 4.8mmD (RN)			8742	8743	8744	8745	8751	8752
Tissue Level 6.5mmD (WN)			8870	8871	8872	8873	8874	
Bone Level 3.3mmD (NC)				8422	8423	8424	8425	8426
Bone Level 4.1mmD (RC)			8170	8171	8172	8173	8174	8175
BLX Regular Base (RB) & Wide Base (WB)			2326	2327	2328	2329	2330	2331
<b>SYBRON® / INNOVA®</b>								
Endopore 3.5mmD (0.9mm Ex Hex)			8851	8852	8853	8854	8855	
Endopore 4.1mmD (0.7mm Ex Hex)		8681		8682	8683	8684	8685	8696
Endopore 5.0mmD (0.9mm Ex Hex)			8691 1.35mm	8692	8693	8694	8695	
Endopore 4.1mm/5.0mmD (One Stage)		8950		8951	8952	8953	8954	8955
Endopore 4.1mmD (Internal Hex)	8145		8146	8147	8148	8149	8150	
Endopore 5.0mmD (Internal Hex)			8164	8165	8166	8167	8168	8169
Entegra 3.25mm/4.0mmD (0.7mm Ex Hex)		8681		8682	8683	8684	8685	8696
Entegra 3.25mmD (0.9mm Ex Hex)			8851	8852	8853	8854	8855	
Entegra 4.7mmD (0.9mm Ex Hex)			8691 1.35mm	8692	8693	8694	8695	
Pitt Easy 3.25mm/3.3mmD			8311	8312	8313	8314	8315	8316
Pitt Easy 3.75mm/3.8mmD			8321	8322	8323	8324	8325	8326
Pitt Easy 4.0mm/4.1mmD			8331	8332	8333	8334	8335	8336
Pitt Easy 4.9mmD			8341	8342	8343	8344	8345	8346
Pro Series XRT Bone Level 3.5mmD			1631	1632	1633	1634	1635	1636
Pro Series XRT Bone Level 4.1mmD			1637	1638	1639	1640	1641	1642
Pro Series XRT Bone Level 4.8mmD		8950		8951	8952	8953	8954	8955

### ABUTMENT TISSUE CUFF HEIGHT

IMPLANT ABUTMENT DESCRIPTION	0.0MM	0.73MM	1.0MM	2.0MM	3.0MM	4.0MM	5.0MM	6.0MM
<b>SYBRON® / INNOVA® CONT'D</b>								
Pro Series Tissue Level (TL) 4.1mm/4.8mmD		8950		8951	8952	8953	8954	8955
Hex Plus 3.5mmD		8105		8106	8107	8108	8109	
Hex Plus 4.1mmD		8681		8682	8683	8684	8685	8696
Hex Plus 5.1mmD			8825 1.1mm	8826	8827	8828	8829	
<b>SARGON®</b>								
External Hex 3.8mmD			8722 1.8mm		8723	8724	8725	8726
<b>TEKKA®</b>								
I-Kone		1937 .70mm	1938 1.5mm		1939		1940	1941 7.0mm
Krestal - 3.2mm			1691	1692	1693	1694	1695	1696
Krestal - 3.4mm	1220		1221	1222	1223	1224	1225	
Krestal - 4.0mm			1226	1227	1228	1229	1230	1231
Krestal - 4.5mm			1232	1233	1234	1235	1236	1237
Krestal - 5.0mm			1238	1239	1240	1241	1242	1243
Krestal - 6.0mm			1244	1245	1246	1247	1248	1249
<b>ZIMMER® / CENTERPULSE® / CALCITEK® / PARAGON®</b>								
Advent 3.7mm/4.7mmD (4.5mmD Platform)		8841 0.71mm		8842	8843	8844	8845	8846
Screw-Vent/ Tapered Screw Vent 3.3mm/3.7mm/4.1mmD (3.5mmD)	8661		8662	8663 2.5mm	8664 3.5mm	8665 4.5mm	8625 5.5mm	8626 6.5mm
Screw-Vent / Tapered Screw Vent 4.7mmD (4.5mmD)	8671		8672	8673	8674	8675	8627	8628
Screw-Vent/ Tapered Screw Vent 6.0mm (5.7mmD)			8180	8181	8182	8183	8184	8185
Calcitek: Integral SD 3.25mmD	8611		8612	8613	8614	8615		
Calcitek: Integral 4.0mmD	8651		8652	8653	8654	8655		
Calcitek: Omniloc 3.25mmD	8611		8612	8613	8614	8615		
Calcitek: Omniloc 4.0mmD	8666		8667	8668	8669	8670		
Calcitek: Spline 3.25mmD			8701	8702	8703	8704	8705	
Calcitek: Spline 3.75mm/4.0mmD			8711	8712	8713	8714	8715	
Calcitek: Spline 5.0mmD		8736 0.86mm		8737	8738	8739	8740	
Calcitek: Swede-Vent 4.0mmD (Ex Hex)		8681		8682	8683	8684	8685	8696
Calcitek: Swede-Vent TL (External Hex)		8681		8682	8683	8684	8685	8696
Calcitek: Taperlock (Ex Hex)		8681		8682	8683	8684	8685	8696
Calcitek: Threadlock 4.0mmD (Ex Hex)		8681		8682	8683	8684	8685	8696
Eztetic 3.1mmD			2218	2219	2220	2221	2222	2223
Paragon: Bio-Vent 3.5mmD (3.5mmD Platform)	8661		8662	8663 2.5mm	8664 3.5mm	8665 4.5mm	8625 5.5mm	8626 6.5mm
Paragon: Bio-Vent 4.5mmD (4.5mmD Platform)	8671		8672	8673	8674	8675	8627	8628

# ATTACHMENTS

## IMPLANT ABUTMENTS/ATTACHMENTS

### ABUTMENT TISSUE CUFF HEIGHT

IMPLANT ABUTMENT DESCRIPTION	0.0MM	0.73MM	1.0MM	2.0MM	3.0MM	4.0MM	5.0MM	6.0MM
<b>ZIMMER® / CENTERPULSE® / CALCITEK® / PARAGON® CONT'D</b>								
Paragon: Core-Vent 4.3mmD (3.5mmD Platform)	8661		8662	8663 2.5mm	8664 3.5mm	8665 4.5mm	8625 5.5mm	8626 6.5mm
Paragon: Core-Vent 5.3mmD (4.5mmD Platform)	8671		8672	8673	8674	8675	8627	8628
Paragon: Micro-Vent 3.25mmD (3.5mmD Platform)	8661		8662	8663 2.5mm	8664 3.5mm	8665 4.5mm	8625 5.5mm	8626 6.5mm
Paragon: Micro-Vent 4.25mmD (4.5mmD Platform)	8671		8672	8673	8674	8675	8627	8628
Paragon: Swiss Plus 3.8mmD			8935	8936	8937	8938		
Paragon: Swiss Plus 4.8mmD		8950		8951	8952	8953	8954	8955

44

LOCATOR® Abutments

## Avoid Challenges When Processing Overdentures and Overdenture Attachments



For predictable processing into full and partial overdentures

- » Simple
- » Versatile
- » Patient-Friendly



Ideal for blocking our undercuts

- » Easy Handling
- » Multiple Uses



LOCATOR® R-Tx: Corrects up to 60° of implant divergence, provides an easy self-aligning path of insertion, esthetic pink housings, and new Duratec abutment coating for longer life and greater wear resistance. 2.85mm vertical, 5.55mm Ø

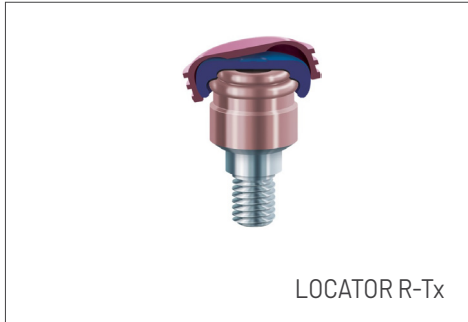

LOCATOR® R-Tx	
Item #	Product
30001-01	R-Tx Zero Retention Insert, Grey (4-Pack)
30002-01	R-Tx Low Retention Insert, Blue (4-Pack)
30003-01	R-Tx Medium Retention Insert, Pink (4-Pack)
30004-01	R-Tx High Retention Insert, White (4-Pack)
30027-01	R-Tx Low Retention, Limited Range, Blue (4-Pack)
30028-01	R-Tx Medium Retention, Limited Range, Pink (4-Pack)
30029-01	R-Tx High Retention, Limited Range, Yellow (4-Pack)
30030-01	R-Tx Attachment System, Mixed Retention Ltd Range Insert (2-Pack)
30012-01	R-Tx Processing Insert (4-Pack)
30013-01	R-Tx Denture Attachment Processing Assembly (4-Pack)
30014-01	R-Tx 3.35mm Abutment Analog (4-Pack) <i>R-Tx analogs for use with narrow diameter implants</i>
30015-01	R-Tx 4mm Abutment Analog (4-Pack) <i>R-Tx analogs for use with regular platform implants</i>
30016-01	R-Tx 5mm Abutment Analog (4-Pack) <i>R-Tx analogs for use with wide diameter implants</i>
30017-01	R-Tx Impression Coping (4-Pack)
30018-01	R-Tx Processing Spacer (4-Pack)
30021-01	R-Tx Retention Insert Tool
4008514	R-Tx Block Out Spacer (20-Pack)
4009665	R-Tx Patient Education Model

# ATTACHMENTS

## IMPLANT ABUTMENTS/ATTACHMENTS

### ABUTMENT TISSUE CUFF HEIGHT

IMPLANT ABUTMENT DESCRIPTION	0.5MM	1.0MM	2.0MM	3.0MM	4.0MM	5.0MM	6.0MM
<b>AB DENTAL®</b>							
3.75mmD (NP)	30200-00	30200-01	30200-02	30200-03	30200-04	30200-05	30200-06
4.5mmD (WP)	30201-00	30201-01	30201-02	30201-03	30201-04	30201-05	30201-06
<b>ACE®</b>							
Bone Level NP		30900-01	30900-02	30900-03	30900-04	30900-05	30900-06
Bone Level RP		30901-01	30901-02	30901-03	30901-04	30901-05	30901-06
Tissue Level RP		31302-01	31302-02	31302-03	31302-04	31302-05	31302-06
3.5mm NP		30510-01	30510-02	30510-03	30510-04	30510-05	30510-06
3.5mm NP Tri-Channel	30500-00 0.25mm	30500-01	30500-02	30500-03	30500-04	30500-05	30500-06
3.5mm NP Internal Connection	30200-00	30200-01	30200-02	30200-03	30200-04	30200-05	30200-06
4.1mm RP		30511-01	30511-02	30511-03	30511-04	30511-05	30511-06
4.3mm RP Tri-Channel	30501-00	30501-01	30501-02	30501-03	30501-04	30501-05	30501-06
4.5mm RP Internal Connection	30201-00	30201-01	30201-02	30201-03	30201-04	30201-05	30201-06
5.0mm WP Tri-Channel		30502-01	30502-02	30502-03	30502-04	30502-05	30502-06
<b>BIOHORIZONS®</b>							
Internal 3.0mmD		30600-01	30600-02	30600-03	30600-04	30600-05	30600-06
Internal 3.5mm/3.8mmD	30200-00	30200-01	30200-02	30200-03	30200-04	30200-05	30200-06
Internal 4.0mm/4.5mm/4.6mmD	30201-00	30201-01	30201-02	30201-03	30201-04	30201-05	30201-06
Internal 5.7mm/5.8mmD		30202-01	30202-02	30202-03	30202-04	30202-05	30202-06
<b>BIO-LOK®</b>							
4.0mm (Ex Hex & Internal Connection)		30306-01	30306-02	30306-03	30306-04	30306-05	30306-06
<b>BIOMET 3I®</b>							
Certain 3.4mmD		30300-01	30300-02	30300-03	30300-04	30300-05	30300-06
Certain 4.1mmD		30301-01	30301-02	30301-03	30301-04	30301-05	30301-06
MicroMiniPlant 3.4mmD (Ex Hex)		30305-01	30305-02	30305-03	30305-04	30305-05	30305-06
MiniPlant 3.75mmD (Ex Hex)		30306-01	30306-02	30306-03	30306-04	30306-05	30306-06
Cylindrical 4.0mmD (Ex Hex)		30306-01	30306-02	30306-03	30306-04	30306-05	30306-06
<b>BLUE SKY BIO®</b>							
MicroMiniPlant 3.4mmD (Ex Hex)		30305-01	30305-02	30305-03	30305-04	30305-05	30305-06
BTI - Biotechnology Institute SL®		30306-01	30306-02	30306-03	30306-04	30306-05	30306-06
Cylindrical 4.0mmD (Ex Hex)		30306-01	30306-02	30306-03	30306-04	30306-05	30306-06
One Stage Regular		31302-01	31302-02	31302-03	31302-04	31302-05	31302-06
One Stage WP		30907-01	30907-02	30907-03	30907-04	30907-05	30907-06
<b>BTI - BIOTECHNOLOGY INSTITUTE SL®</b>							
External Hex 4.1mmD		30306-01	30306-02	30306-03	30306-04	30306-05	30306-06

### ABUTMENT TISSUE CUFF HEIGHT

IMPLANT ABUTMENT DESCRIPTION	0.5MM	1.0MM	2.0MM	3.0MM	4.0MM	5.0MM	6.0MM
<b>DENTSPLY® / ASTRA®</b>							
Ankylos C/X (Conical Connection)		30715-01	30715-02	30715-03	30715-04	30715-05	30715-06
EV 3.6mmD		30700-01	30700-02	30700-03	30700-04	30700-05	30700-06
EV 4.2mmD		30701-01	30701-02	30701-03	30701-04	30701-05	30701-06
EV 4.8mmD		30702-01	30702-02	30702-03	30702-04	30702-05	30702-06
TX 3.5mm/4.0mmD		30706-01	30706-02	30706-03	30706-04	30706-05	30706-06
4.5mm/5.0mmD		30707-01	30707-02	30707-03	30707-04	30707-05	30707-06
Frialit-2 / Xive 3.4mmD		30711-01	30711-02	30711-03	30711-04	30711-05	30711-06
Frialit-2 / Xive 3.8mmD		30712-01	30712-02	30712-03	30712-04	30712-05	30712-06
Frialit-2 / Xive 4.5mmD		30713-01	30713-02	30713-03	30713-04	30713-05	30713-06
Frialit-2 / Xive 5.5mmD		30714-01	30714-02	30714-03	30714-04	30714-05	30714-06
<b>IMTEC®</b>							
Self Tapping 3.75mmD (Ex Hex)		30306-01	30306-02	30306-03	30306-04	30306-05	30306-06
Universal 3.4mm/4.0mmD (Ex Hex)		30306-01	30306-02	30306-03	30306-04	30306-05	30306-06
<b>IMPLANT DIRECT®</b>							
Legacy 3.5mmD (Internal Hex)	30200-00	30200-01	30200-02	30200-03	30200-04	30200-05	30200-06
Legacy 4.5mmD (Internal Hex)	30201-00	30201-01	30201-02	30201-03	30201-04	30201-05	30201-06
Legacy 5.7mmD (Internal Hex)		30202-01	30202-02	30202-03	30202-04	30202-05	30202-06
RePlus / RePlant / ReActive 3.5mmD (Trilobe NP)	30500-00	30500-01	30500-02	30500-03	30500-04	30500-05	30500-06
RePlus / RePlant / ReActive 4.3mmD (Trilobe RP)	30501-00	30501-01	30501-02	30501-03	30501-04	30501-05	30501-06
RePlus / RePlant / ReActive 5.0mmD (Trilobe WP)		30502-01	30502-02	30502-03	30502-04	30502-05	
SwishTapered / SwishPlus 4.8mmD		31302-01	31302-02	31302-03	31302-04	31302-05	31302-06
<b>IMZ®</b>							
3.3mmD (Ex Hex)		30306-01 1.2mm	30306-02	30306-03	30306-04	30306-05	30306-06
4.0mmD (Ex Hex)		30306-01	30306-02	30306-03	30306-04	30306-05	30306-06
<b>INTRA-LOCK SYSTEM INTERNATIONAL®</b>							
Threaded 3.75mm/4.0mmD (Ex Hex)		30306-01	30306-02	30306-03	30306-04	30306-05	30306-06
<b>KEYSTONE / LIFECORE BIOMEDICAL®</b>							
3.3mm/4.0mmD (Ex Hex)		30306-01	30306-02	30306-03	30306-04	30306-05	30306-06
5.0/5.5/6.0mmD (Ex Hex)		31202-01	31202-02	31202-03	31202-04	31202-05	31202-06
Stage-1 Regular		31302-01	31302-02	31302-03	31302-04	31302-05	31302-06
Restore RD 3.75mm/4.0mmD (Ex Hex)		30306-01	30306-02	30306-03	30306-04	30306-05	30306-06
<b>MEGAGEN® / INTEGRATED DENTAL SYSTEMS®</b>							
AnyRidge 3.5mmD (Internal Connection)		32201-01	32201-02	32201-03	32201-04	32201-05	32201-06

# ATTACHMENTS

## IMPLANT ABUTMENTS/ATTACHMENTS

### ABUTMENT TISSUE CUFF HEIGHT

IMPLANT ABUTMENT DESCRIPTION	0.5MM	1.0MM	2.0MM	3.0MM	4.0MM	5.0MM	6.0MM
<b>MIS - MEDICAL IMPLANT SYSTEM®</b>							
Internal Hex 3.75mm/4.2mmD (SP)	30200-00	30200-01	30200-02	30200-03	30200-04	30200-05	30200-06
Internal Hex 5.0mmD (WP)	30201-00	30201-01	30201-02	30201-03	30201-04	30201-05	30201-06
External SP (Ex Hex)		30306-01	30306-02	30306-03	30306-04	30306-05	30306-06
Mistral Internal Octagon (Stage One)		31302-01	31302-02	31302-03	31302-04	31302-05	31302-06
<b>NEODENT®</b>							
Cone Morse		32301-01	32301-02	32301-03	32301-04	32301-05	32301-06
Grand Morse		32700-01	32700-02	32700-03	32700-04	32700-05	32700-06
<b>NOBEL BIOCARE® / BRANEMARK® / STERIOSS®</b>							
Active / Conical Connection NP		30506-01	30506-02	30506-03	30506-04	30506-05	30506-06
Active / Conical Connection RP		30507-01	30507-02	30507-03	30507-04	30507-05	30507-06
Active / Conical Connection WP		30508-01	30508-02	30508-03	30508-04	30508-05	30508-06
Replace Select NP (3.5mmD, Trilobe)	30500-00	30500-01	30500-02	30500-03	30500-04	30500-05	30500-06
Replace Select RP (4.3mmD, Trilobe)	30501-00	30501-01	30501-02	30501-03	30501-04	30501-05	30501-06
Replace Select WP (5.0mmD, Trilobe)		30502-01	30502-02	30502-03	30502-04	30502-05	30502-06
Branemark NP (3.3mmD, Ex Hex)		30510-01	30510-02	30510-03	30510-04	30510-05	30510-06
Branemark RP (3.75mm/4.0mm/5.0mmD, Ex Hex)		30511-01	30511-02	30511-03	30511-04	30511-05	30511-06
Branemark WP (5.0mmD, Ex Hex)		30512-01	30512-02	30512-03	30512-04	30512-05	30512-06
Nobel Speedy NP (3.5mmD, Ex Hex)		30510-01	30510-02	30510-03	30510-04	30510-05	30510-06
Nobel Speedy RP (4.3mmD, Ex Hex)		30511-01	30511-02	30511-03	30511-04	30511-05	30511-06
Replace Ex Hex NP (3.5mmD)		30510-01	30510-02	30510-03	30510-04	30510-05	30510-06
Replace Ex Hex RP (4.3mmD)		30511-01	30511-02	30511-03	30511-04	30511-05	30511-06
Replace Ex Hex WP (5.0mmD)		30512-01	30512-02	30512-03	30512-04	30512-05	30512-06
Hex-Lock (HL) 3.8mm/4.5mmD (Ex Hex)		30511-01	30511-02	30511-03	30511-04	30511-05	30511-06
<b>OCO BIOMEDICAL®</b>							
3.0mmD		31500-01 0.75mm	31500-02	31500-03	31500-04	31500-05	31500-06
3.5mmD	30200-00	30200-01	30200-02	30200-03	30200-04	30200-05	30200-06
4.5mmD	30201-00	30201-01	30201-02	30201-03	30201-04	30201-05	30201-06
<b>OSSTEM® / HIOSSEN USA®</b>							
SS Internal / HS Regular 4.8mmD		31302-01	31302-02	31302-03	31302-04	31302-05	31302-06
SS Internal Octagon RP		31606-01 1.5mm	31606-02	31606-03	31606-04	31606-05	31606-06
US Mini 3.3mm / 3.5mmD (Ex Hex)		30510-01	30510-02	30510-03	30510-04	30510-05	30510-06
US Regular/ HU Regular 3.75mm /4.0mmD (Ex Hex)		30511-01	30511-02	30511-03	30511-04	30511-05	30511-06
ET Mini		31600-01	31600-02	31600-03	31600-04	31600-05	31600-06
ET Regular		31601-01	31601-02	31601-03	31601-04	31601-05	31601-06
SSII/III 4.5/4.8		31606-01	31606-02	31606-03	31606-04	31606-05	31606-06
<b>OSTEO-IMPLANT CORPORATION®</b>							
3.25mm SD, 3.75mm ST, 4.0mm DT		30511-01	30511-02	30511-03	30511-04	30511-05	30511-06

### ABUTMENT TISSUE CUFF HEIGHT

IMPLANT ABUTMENT DESCRIPTION	0.5MM	1.0MM	2.0MM	3.0MM	4.0MM	5.0MM	6.0MM
<b>SOUTHERN IMPLANT USA®</b>							
Tri-Nex 3.5mmD	30500-00	30500-01	30500-02	30500-03	30500-04	30500-05	30500-06
Tri-Nex 4.3mmD	30501-00	30501-01	30501-02	30501-03	30501-04	30501-05	30501-06
Tri-Nex 5.0mmD		30502-01	30502-02	30502-03	30502-04	30502-05	
IT 4.8mmD (Internal Octagon)		31302-01	31302-02	31302-03	31302-04	31302-05	31302-06
<b>STERNGOLD IMPLAMED®</b>							
Hex Cylinder 3.3mm/4.0mmD		30511-01	30511-02	30511-03	30511-04	30511-05	30511-06
Hex Screw 3.75mm/4.0mmD		30511-01	30511-02	30511-03	30511-04	30511-05	30511-06
<b>STRAUMANN®</b>							
Tissue Level 3.5mmD (NNC)		30405-01	30405-02	30405-03	30405-04	30405-05	30405-06
Tissue Level 4.8mmD (RN)		30406-01	30406-02	30406-03	30406-04	30406-05	30406-06
Tissue Level 6.5mmD (WN)		30407-01 1.5mm	30407-02	30407-03	30407-04	30407-05	30407-06
Bone Level 3.3mmD (NC)		30401-01	30401-02	30401-03	30401-04	30401-05	30401-06
Bone Level 4.1mmD (RC)		30402-01	30402-02	30402-03	30402-04	30402-05	30402-06
BLX Regular Base (RB) & Wide Base (WB)		30410-01	30410-02	30410-03	30410-04	30410-05	30410-06
<b>SYBRON® / INNOVA®</b>							
Endopore 4.1mmD (0.7mm Ex Hex)		30511-01	30511-02	30511-03	30511-04	30511-05	30511-06
Endopore 4.1mm/5.0mmD (One Stage)		31302-01	31302-02	31302-03	31302-04	31302-05	31302-06
Entegra 3.25mm/4.0mmD (0.7mm Ex Hex)		30511-01	30511-02	30511-03	30511-04	30511-05	30511-06
Pro Series XRT Bone Level 4.8mmD		31302-01	31302-02	31302-03	31302-04	31302-05	31302-06
Pro Series Tissue Level (TL) 4.1mm/4.8mmD		31302-01	31302-02	31302-03	31302-04	31302-05	31302-06
Hex Plus 4.1mmD		30511-01	30511-02	30511-03	30511-04	30511-05	30511-06
<b>ZIMMER® / CENTERPULSE® / CALCITEK® / PARAGON®</b>							
Screw-Vent/ Tapered Screw Vent 3.3mm/3.7mm/4.1mm Diameter (3.5mm Dia.)	30200-00	30200-01	30200-02	30200-03	30200-04	30200-05	30200-06
Screw Vent / Tapered Screw Vent 4.7mm Diameter (4.5mm Platform Dia.)	30201-00	30201-01	30201-02	30201-03	30201-04	30201-05	30201-06
Screw-Vent/ Tapered Screw Vent 6.0mm Diameter (5.7mm Platform Dia.)		30202-01	30202-02	30202-03	30202-04	30202-05	30202-06
Calcitek: Spline 4.1mm (Ex Hex)		30207-01	30207-02	30207-03	30207-04	30207-05	30207-06
Calcitek: Swede-Vent 4.0mm Diameter (Ex Hex)		30511-01	30511-02	30511-03	30511-04	30511-05	30511-06
Calcitek: Swede-Vent TL (External Hex)		30511-01	30511-02	30511-03	30511-04	30511-05	30511-06
Calcitek: Taperlock (Ex Hex)		30511-01	30511-02	30511-03	30511-04	30511-05	30511-06
Calcitek: Threadlock 4.0mm (Ex Hex)		30511-01	30511-02	30511-03	30511-04	30511-05	30511-06
Paragon: Bio-Vent 3.5mm Diameter (3.5mm Platform Dia.)	30200-00	30200-01	30200-02	30200-03	30200-04	30200-05	30200-06
Paragon: Bio-Vent 4.5mm Diameter (4.5mm Platform Dia.)	30201-00	30201-01	30201-02	30201-03	30201-04	30201-05	30201-06
Paragon: Core-Vent 4.3mm Diameter (3.5mm Platform Dia.)	30200-00	30200-01	30200-02	30200-03	30200-04	30200-05	30200-06
Paragon: Core-Vent 5.3mm Diameter (4.5mm Platform Dia.)	30201-00	30201-01	30201-02	30201-03	30201-04	30201-05	30201-06
Paragon: Micro-Vent 3.25mm Diameter (3.5mm Platform Dia.)	30200-00	30200-01	30200-02	30200-03	30200-04	30200-05	30200-06
Paragon: Micro-Vent 4.25mm Diameter (4.5mm Platform Dia.)	30201-00	30201-01	30201-02	30201-03	30201-04	30201-05	30201-06
Paragon: Swiss Plus 4.8mm Diameter		31302-01	31302-02	31302-03	31302-04	31302-05	31302-06
Internal 3.5mm/3.8mmD	30200-00	30200-01	30200-02	30200-03	30200-04	30200-05	30200-06
Internal 4.0mm/4.5mm/4.6mmD	30201-00	30201-01	30201-02	30201-03	30201-04	30201-05	30201-06
Internal 5.7mm/5.8mmD		30202-01	30202-02	30202-03	30202-04	30202-05	30202-06

# ATTACHMENTS

## IMPLANT ABUTMENTS/ATTACHMENTS

**LOCATOR® Overdenture Implant (LODI):** designed to provide a specialty overdenture implant /attachment option where narrow ridges, minimized surgical invasiveness and financial considerations play a role in the implant choice and where a superior overdenture attachment can be utilized with no compromise. The best of both worlds—a narrow diameter implant utilizing the proven LOCATOR® Attachment!

50

LOCATOR Overdenture Implant System

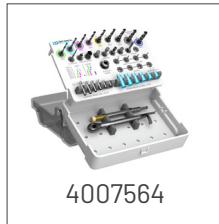

### LODI NDI Implant System

Item #	Product
4007351	LODI Attachment, 2.5mm
4007352	LODI Attachment, 4.0mm
4007318	LODI Attachment, 3.0mm
4007319	LODI Attachment, 5.0mm
4007320	LODI Attachment, 6.0mm
4007365	LODI Direction Indicator
4007538	LODI Drill 1.6mm
4007539	LODI Drill 2.1mm
4007541	LODI Drill 2.6mm
4007374	LODI Drill Extender
4007540	LODI Drill 2.4mm
4007560	LODI Surgical Tray
4007561	LODI Standard Surgical Kit
4007564	LODI Premium Surgical Kit
4007450	LODI Implant 2.4mm x 10mm, 2.5mm Cuff
4007451	LODI Implant 2.4mm x 12mm, 2.5mm Cuff
4007452	LODI Implant 2.4mm x 14mm, 2.5mm Cuff

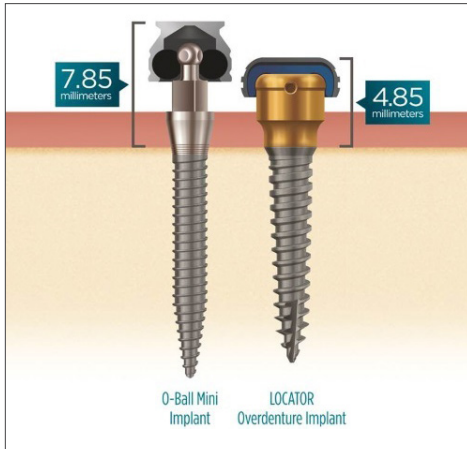

### LODI NDI Implant System

Item #	Product
4007455	LODI Implant 2.4mm x 10mm, 4.0mm Cuff
4007456	LODI Implant 2.4mm x 12mm, 4.0mm Cuff
4007457	LODI Implant 2.4mm x 14mm, 4.0mm Cuff
4007460	LODI Implant 2.9mm x 10mm, 2.5mm Cuff
4007461	LODI Implant 2.9mm x 12mm, 2.5mm Cuff
4007462	LODI Implant 2.9mm x 14mm, 2.5mm Cuff
4007465	LODI Implant 2.9mm x 10mm, 4.0mm Cuff
4007466	LODI Implant 2.9mm x 12mm, 4.0mm Cuff
4007467	LODI Implant 2.9mm x 14mm, 4.0mm Cuff
4007470	LODI Implant 3.5mm x 10mm, 2.5mm Cuff
4007477	LODI Implant 3.5mm x 14mm, 4.0mm Cuff
4007476	LODI Implant 3.5mm X 12mm, 4.0mm Cuff
4007475	LODI Implant 3.5mm x 10mm, 4.0mm Cuff
4007471	LODI Implant 3.5mm x 12mm, 2.5mm Cuff
4007472	LODI Implant 3.5mm x 14mm, 2.5mm Cuff
4007362	LODI Torque Indicating Ratchet Wrench
4007357	LODI Implant Latch Driver

**Call for additional implant diameter options!**

# ATTACHMENTS

## IMPLANT ABUTMENTS/ATTACHMENTS

**OT Equator** is the smallest dimensional overdenture attachment, in terms of size, available on the market today. The maximum vertical dimension (attachment, retentive cap and housing) is only 2.1mm with a diameter (attachment, retentive cap and housing) of 4.5mm.

The attachment system includes retentive caps in various colors corresponding to different levels of retention as well as the Smartbox titanium housing for retentive caps. The innovative Smartbox design allows a passive insertion of the cap even under extreme divergence conditions up to 50° thanks to a tilting mechanism with a pivoting fulcrum. The Smartbox is compatible with the OT Equator direct attachment.

Call for information on OT Equator attachments which are available with heights ranging from 0.5mm to 7.0mm for a variety of implant systems and may even be custom-made if needed.

52

OT Equator® & OT Equator® Smartbox



### OT Equator® & OT Equator® Smartbox

Item #	Product
2239GSF	Equator 1.6mm Threaded Sleeve
2192ECE	Equator Cap Assortment Kit
244CAIN	Equator Impression Copings (2-Pack)
20144AE	Equator Laboratory Analogs (2-Pack)
20760CE	Equator Latch-Type Driver
2140CEN	Equator Processing Caps - Black (4-Pack)
2140CET	Equator Retentive Caps - Clear, Standard (4-Pack)
2140CER	Equator Retentive Caps - Pink, Soft (4-Pack)
2140CEV	Equator Retentive Caps - Violet, Strong (4-Pack)
2140CEG	Equator Retentive Caps - Yellow, Extra Soft (4-Pack)
2335SBC	Equator SmartBox
2330SBE	Equator SmartBox Housing
2335CSB	Equator SmartBox Processing Caps - Black (4-Pack)
2141CAE	Equator SS Housings (2-Pack)
2141CTE	Equator Ti Housings (2-Pack)

**Sphero Flex** is a self-parallel ball attachment correcting up to 15 of divergence for use with 2.5mm ball abutments. Sphero Block is a fixed sphere available in either 1.8 or 2.5mm ball diameters.

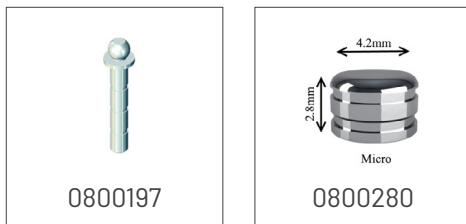
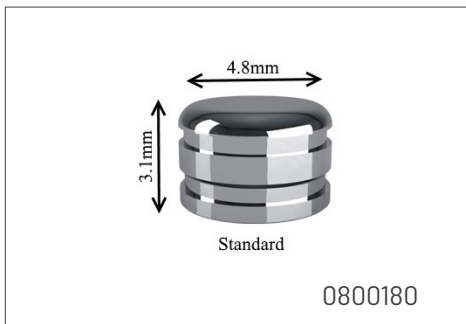
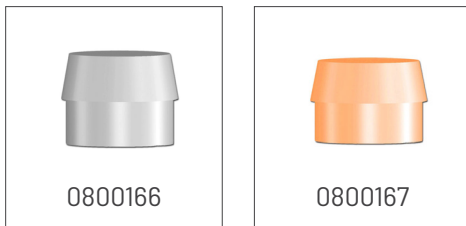
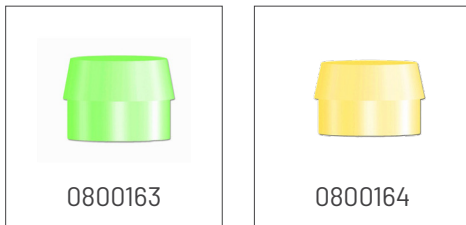
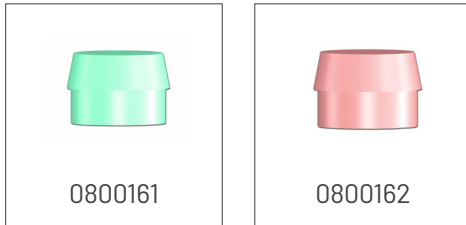

### Sphero Flex and Block Ball Attachments

Item #	Product
0800161	2.5mm Retention Caps—Light Green (6-Pack) <i>For worn spheres, Rigid Retention (2.2mm)</i>
0800162	2.5mm Retention Caps—Pink (6-Pack) <i>Standard- 1.65lbs</i>
0800163	2.5mm Retention Caps—Green (6-Pack) <i>Soft, gummy for patient comfort</i>
0800164	2.5mm Retention Caps—Yellow (6-Pack) <i>Soft- 1.21lbs</i>
0800166	2.5mm Retention Caps—White (6-Pack) <i>Strong- 2.87lbs</i>
0800167	2.5mm Retention Caps—Orange (6-Pack) <i>For worn spheres, Elastic Retention (2.2mm)</i>
0800194	Cap Insertion Tool 2.5mm/1.8mm
0800197	Sphero 2.5mm Analog (2-Pack)
0800180	2.5mm Stainless Cap Housing (2-Pack)
0800280	1.8mm Stainless Cap Housing (2-Pack)
0800720	Sphero 1.8mm Analog (2-Pack)
0800264	1.8mm Retention Caps—Yellow (6-Pack) - Soft - 1.00lbs
0800262	1.8mm Retention Caps—Pink (6-Pack) - Standard - 1.10lbs
0800266	1.8mm Retention Caps—White (6-Pack) - Strong - 2.20 lbs
0800263	1.8mm Retention Caps—Green (6-Pack) <i>Soft, gummy for patient comfort</i>
0800169	2.5mm Retention Caps—Black (6-Pack) Processing Cap
0800269	1.8mm Retention Caps—Black (6-Pack) Processing Cap
0800267	1.6mm Retention Caps—Orange (6-Pack) <i>For worn spheres, Elastic Retention (1.6mm)</i>
0800261	1.6mm Retention Caps—Light Green (6-Pack) <i>For worn spheres, Rigid Retention (1.6mm)</i>
0800250	Sphero Directional Rings

# ATTACHMENTS

## REMOVABLE PARTIAL DENTURE ATTACHMENTS

The demand for partial dentures is expected to grow at 6.8% year to year over the next decade. Partner with the company that can help you provide the best patient specific solutions.

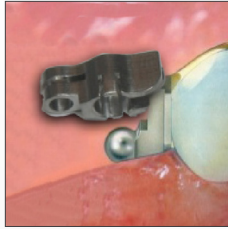

### AMERICAN MINI

*Kennedy Class I semi-precision attachment Mini-Dalbo/Swiss Mini*

- » 3mm tall, male 2.5mm Ø, female 3.5mm Ø

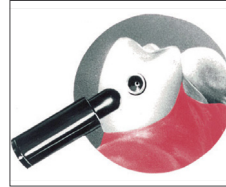

### IC ATTACHMENT

*Kennedy Class III Hannes Anchor*

- » male: 5.2mm length, 2mm Ø, 1mm nose
- » female: 2mm Ø, 0.8mm deep



### CEKA REVAX

*Kennedy Class I Precision Resilient attachment*

- » M2 (small): 3.80mm tall, 3.40mm Ø
- » M3 (standard): 4.35mm tall, 4.40mm Ø

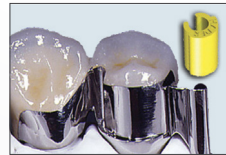

### VERTIX

*Kennedy Class IV*

- » 6mm (may be reduced to 3mm) tall, 3.3mm Ø

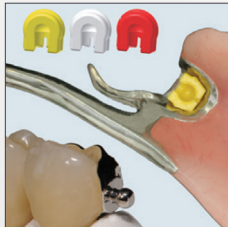

### SAGIX

*Ideal for Kennedy Class I VKS-SG, OT Strategy, Allegro*

- » 1.7mm ball: 3.10mm tall, 3.10mm Ø
- » 2.2mm ball: 4.10mm tall, 4.20mm Ø



### O-RING DISTAL EXTENSION

*Kennedy Class I*

- » 5.2mm (may be reduced to 2.5mm) tall, 2.00mm Ø

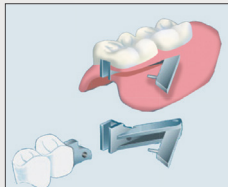

### MAYS UNILATERAL

*Ideal for Kennedy Class II*

- » 3mm tall, 2mm Ø

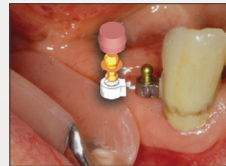

### SPHERO RETROFIT

- » replacing worn extracoronal attachments, such as the ERA or Ceka
- » 1.5mm tall ball, 1.8mm Ø

**Sphero Retrofit Kits:** designed to retrofit worn ERA, Ceka, and other worn extracoronaral and overdenture attachments. Use Ceka Site or metal-to-metal bonding composite. retrofit: 2.7mm\* vertical, 4.3mm Ø 2 TiN coated spheres, 1 mandrel/ key, 2 pink females, 2 protector disks. \*\*metal housings 0800280 available separately\*\*

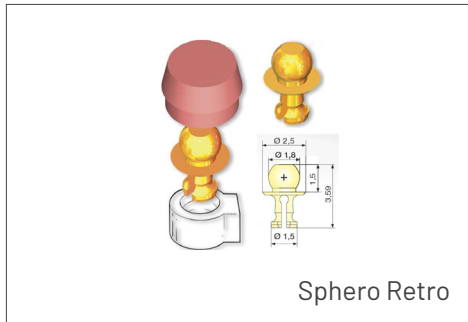

### Sphero Retrofit Kit

Item #	Product
0800140	Sphero Retrofit Kit

Sphero Retrofit Kit

**Sagix Attachment:** Sagital 1.7 and 2.2mm Ball attachment with female that engages the full sphere for maximum retention. Unique female engages entire sphere for more retention and less attachment wear. Compatible with Bredent VKS-SG 1.7 and 2.2mm balls. 1.7mm: 3.1mm vertical, 3.1mm Ø. 2.2mm: 4.1mm vertical, 4.2mm Ø



### Sagix

Item #	Product
0101305	Sagix 1.7 Complete Plastic w/ housing 1 plastic male, 1 each yellow, white and red females, 1 processing pink female, 1 metal housing
0101356	Sagix 1.7 Complete Metal w/ housing 1 metal male, 1 each yellow, white and red females, 1 processing pink female, 1 metal housing
0101357	Sagix 1.7 Complete Metal 1 metal male, 1 each yellow, white and red females, 1 processing pink female
0101325-2	Sagix 1.7 Metal Housing (2-Pack) CoCr
0101331-2	Sagix 1.7 Model Analog (2-Pack)
0101316-6	Sagix 1.7 Female Dupl Dummy (6-Pack)
0101316-50	Sagix 1.7 Female Dupl Dummy (50-Pack)
0101312-6	Sagix 1.7 White Female- Reduced (6-Pack) white = 1.5lbs retention
0101312-50	Sagix 1.7 White Female- Reduced (50-Pack)

Sagix

# ATTACHMENTS

## EXTRACORONAL ATTACHMENTS

Sagix

56

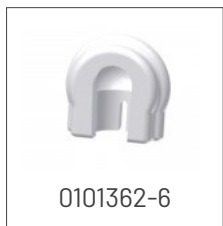
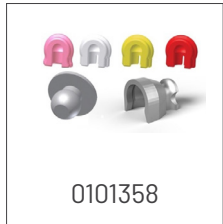
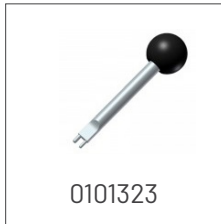
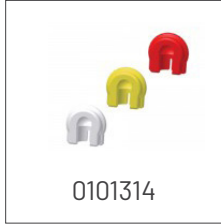
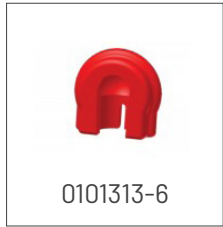
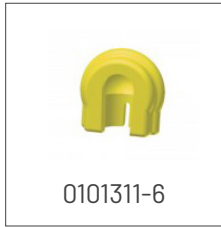

### Sagix (cont'd)

Item #	Product
0101311-6	Sagix 1.7 Yellow Female- Standard (6-Pack) <i>yellow = 2.3lbs retention</i>
0101311-50	Sagix 1.7 Yellow Female- Standard (50-Pack)
0101313-6	Sagix 1.7 Red Female- Increased (6-Pack) <i>red = 3.1lbs retention</i>
0101313-50	Sagix 1.7 Red Female- Increased (50-Pack)
0101314	Sagix 1.7 Female Combo pack <i>2 white, 2 yellow, 2 red 1.7mm females</i>
0101300P	Sagix Universal Parallel Mandrel
0101323	Sagix Universal Insertion Tool
0101307	Sagix 2.2 Complete Plastic w/ housing <i>1 plastic male, 1 each yellow, white and red females, 1 processing pink female, 1 metal housing.</i>
0101358	Sagix 2.2 Complete Metal w/ housing <i>1 metal male, 1 each yellow, white and red females, 1 processing pink female, 1 metal housing</i>
0101274	Universal Threaded Ball 2.2mm (M2 x .040)
0101375-2	Sagix 2.2 Metal Housing (2-Pack) CoCr
0101381-2	Sagix 2.2 Model Analog (2-Pack)
0101366-6	Sagix 2.2 Female Dupl Dummy (6-Pack)
0101366-50	Sagix 2.2 Female Dupl Dummy (50-Pack)
0101362-6	Sagix 2.2 White Female- Reduced (6-Pack) <i>white = 1.7 lbs retention</i>
0101362-50	Sagix 2.2 White Female- Reduced (50-Pack)

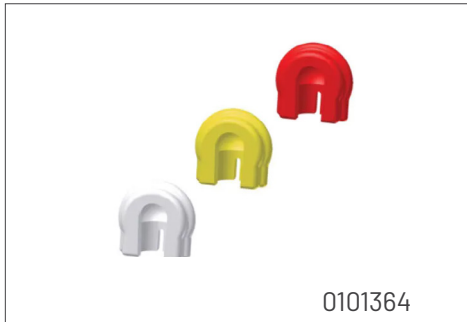

Sagix (cont'd)	
Item #	Product
0101361-6	Sagix 2.2 Yellow Female- Standard (6-Pack) <i>yellow = 2.5 lbs retention</i>
0101361-50	Sagix 2.2 Yellow Female- Standard (50-Pack)
0101363-6	Sagix 2.2 Red Female- Increased (6-Pack) <i>red = 3.3 lbs retention</i>
0101363-50	Sagix 2.2 Red Female- Increased (50-Pack)
0101364	Sagix 2.2 Female Combo pack

**Vertex® Attachment:** extracoronral slide attachment providing limited resilience and excellent lateral stability and esthetics with castable housing: 3.0mm vertical, 3.3mm Ø with metal housing: 3.0mm vertical, 4.1mm Ø

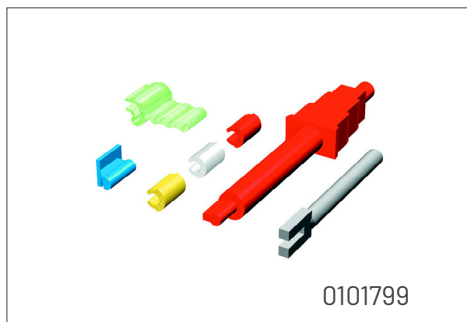

Vertex	
Item #	Product
0101799	Vertex P Combo Kit (2-Pack) <i>2 castable P males, 2 castable housings, 1 insertion tool, 1 paralleling mandrel, 6 female riders (2 white, 2 yellow, 2 red)</i>

**American Mini®:** (Mini Dalbo): extracoronral attachment allowing hinge movements with excellent stability mini: 3.0mm vertical, male 2.5mm Ø, female 3.5mm Ø

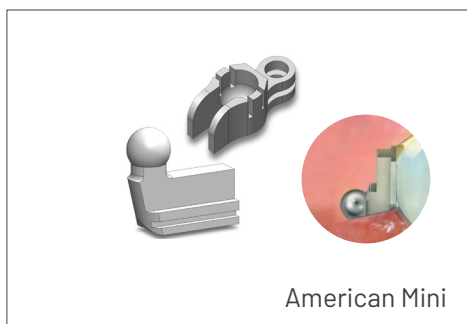

American Mini (Mini Dalbo)	
Item #	Product
1800000	American Mini Complete <i>Stainless Female and Delrin Male</i>

# ATTACHMENTS

## EXTRACORONAL ATTACHMENTS

**O-Ring Distal Extension:** provides free movement in all planes for maximum abutment protection. A proven retentive system utilizing an easily replaceable rubber O ring. Resilient attachment with vertical and hinge stress-breaking action for free-end and bounded partials.

OSO Distal Extension

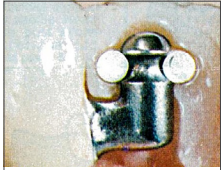

O-Ring



1500150



1500153

### OSO Distal Extension

Item #	Product
1500150	O-Ring Distal Extension Attachment #3 <i>Burn-out plastic pattern, 3 white o-rings, 1 red o-ring</i>
1500153	O-Ring Distal Ext. Paralleling Mandrel #3
1500502	O-Ring Metal Retainer Standard #3

58

**Mays® Unilateral:** designed specifically for the unilateral distal extension. Does not require a lingual or palatal arm. Metal framework is not required; parallelism is not necessary, even on bilateral cases. Requires: 3mm tall, 2mm Ø

Mays® Unilateral

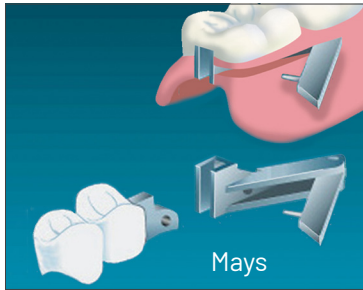

Mays

### Mays® Unilateral

Item #	Product
0200060	Mays Unilateral Attach UR/LL

**IC Attachment:** a popular spring loaded plunger attachment that provides resilient movement for abutment protection without requiring an abutment crown. The IC attachment requires a 180 degree reciprocal lingual arm if free end.  
 Universal Male: 5.2mm length, 2mm Ø, 1mm nose Universal Female: 2mm Ø, 0.8mm deep



IC

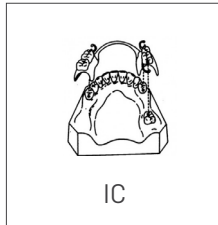

IC

### Universal IC Attachment

Item #	Product
1800000	Universal IC Attachment

Universal IC Attachment

**Ceka® and Ceka Revax®:** adjustable precision attachment allowing vertical, hinge, & rotational movements M2 Revax: 3.8mm vertical, 3.4mmØ M3 Revax: 4.35mm vertical, 4.4mmØ M3 Classic: 3.55mm vertical, 4.3mmØ M2 female attachments only



2RP0075



2RP0061

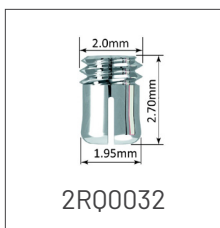

2RQ0032

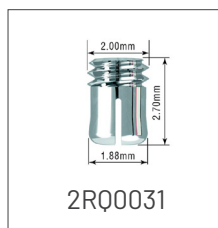

2RQ0031

### Ceka® and Ceka Revax

Item #	Product
<b>M2 Retention Caps</b>	
2RP0061	M2 Pallax Solder Cap (2-Pack)
2RP0075	M2 Acrylic Retention Caps (2-Pack)
2RP0095	M2 Axial Acrylic Retention Cap (2-Pack)
<b>M2 Male Spring Pins</b>	
2RQ0031	M2 Spring Pins Standard (2-Pack)
2RQ0032	M2 Spring Pins 195 (2-Pack)
2RQ0033	M2 Spring Pins 202 (2-Pack)
2RP0096	M2 Space Maintainer

Ceka® and Ceka Revax

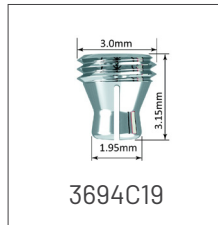
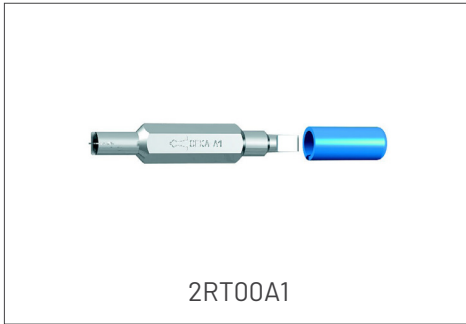

### Ceka® and Ceka Revax

Item #	Product
<b>M2 Attachment Tools</b>	
2RT00A1	A1 Activating Tool & Driver
<b>M3 Male Spring Pins</b>	
3X694C2	M3 694C Standard Spring Pin (2-Pack)
3694C19	M3 694C Spring Pin 195 (2-Pack)
3694C20	M3 694C Spring Pin 202 (2-Pack)
3694C29	M3 694C Spring Pin 209 (2-Pack)
3694CL8	Ceka Sizer
3TL03H1	M3 Working Dummy Pin (2-Pack)
3X694B0	M3 Space Maintainer 694B
<b>M3 Retention Caps</b>	
3694KS2	M3 Acrylic Retention Cap (2-Pack) 694 AKS
3X694A2	M3 Solder Retention Cap (2-Pack) 694 AS
3X6AKS2	M3 694 AKS2 Acrylic Retention (2-Pack)

**Splintastik®:** a very simple plastic male and female rod and tube for use in anterior segmented bridgework. The female features a smooth ceramic insert to assure accurate castings. Small 0.8mm diameter Large 1.2mm diameter.



0200001



0200003

Splintastik	
Item #	Product
0200001	Splintastik Starter Kit 2 each: Large Male, Female, and ceramic insert 2 each: Small Male, Female, and ceramic insert 1 each: Small and Large Mandrels, and Precision Reamers
0200003	Splintastik Refill LG (6-Pack) Large Male, Female, and Ceramic insert, size 1.2mm Ø

Splintastik

61

**Better Plastic Dovetail (BPD):** a precision stress breaker ideal for posterior bridges as well as Intracoronal semi-precision slide attachment. Rigid attachment (always use a retentive clasp arm) with friction (not adjustable) retention. Ideal for nonparallel abutments and segmented units. Inside of female rounded to facilitate devesting and avoid attachment wear. Built in paralleling mandrels for both male and female.

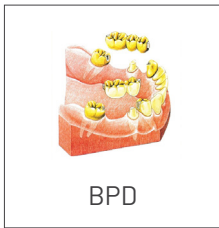

BPD

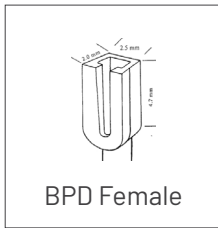

BPD Female

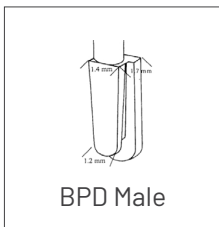

BPD Male

Double Mandrel BPD	
Item #	Product
0200040-6	BPD (Better Plastic Dovetail)(6-Pack)
0200040-12	BPD (Better Plastic Dovetail)(12-Pack)
0200040-50	BPD (Better Plastic Dovetail)(50-Pack)
0200040-100	BPD (Better Plastic Dovetail)(100-Pack)

Double Mandrel BPD

# TRILOR®

# HIGH PERFORMANCE POLYMER

TriLor is a millable fiber-reinforced resin material designed for suprastructures for full arch restorations and bridge frameworks.

This super-strong resin flexes and bends under stress, transferring less energy to the implants, making it an ideal support material for implant restorations.

- Lightweight and Esthetic
- Full Covalent Bond
- Time and Cost Savings



**Fabricated at the bench in under  
30 minutes with a handpiece!**

## THE CHOICE IS YOURS

### DIGITAL

TriLor 98 and 95  
CAD/CAM Pucks



### ANALOG

3 Different  
Thicknesses



### See What our Customers Say

*"Predictable outcome is predictable income. I use TriLor as a tool to make my implant retained cases predictable."*

- Jeremy Wohlers, CDT  
Owner of Esthetics in Function Dental Lab

*"TriLor has improved workflow in my laboratory and chairside while still achieving a very esthetic outcome"*

- Eugene Royzengurt  
Owner of Apple Dental Lab

TriLor® is a millable fiber-reinforced resin material designed for suprastructures for full arch restorations and bridge frameworks. This super-strong resin flexes and bends under stress, transferring less energy to the implants, making it an ideal support material for implant restorations. The TriLor® Arch uniquely allows the Dental Professional to design the framework using a lathe or handpiece. CAD/CAM TriLor® Pucks also available.



### Fiberglass Technology

Item #	Product
50000-35	TriLor Arch, 3.5mm (3-Pack)
50000-55	TriLor Arch, 5.5mm (3-Pack)
50000-75	TriLor Arch, 7.5mm (3-Pack)
50000-16	TriLor 98 CAD Puck, 16mm
50000-16P	TriLor 98 CAD Puck Pink, 16mm
50000-20	TriLor 98 CAD / CAM Puck, 20mm
50000-20P	TriLor 98 CAD / CAM Puck Pink, 20mm
50000-25	TriLor 98 CAD / CAM Puck, 25mm
50005-16	TriLor 95 CAD / CAM Puck, 16mm
50005-20	TriLor 95 CAD / CAM Puck, 20mm
50005-25	TriLor 95 CAD / CAM Puck, 25mm

### TRILOR® INDICAITONS FOR SUPRASTRUCTURE DESIGN

- A. Minimum must be 7mm<sup>2</sup> (3.5mm x 2mm)
- B. Minimum thickness around cylinders is 0.8mm
- C. Maximum cantilever is 10mm

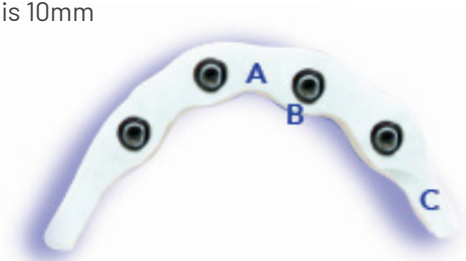

### TRILOR® MATERIAL COMPARISON

Properties	TriLor®	Trinia™	PEKKTON®	JUVORA® PEEK	Zirconia + Ittrio	CrCo
Tensile Strength	380 MPa	169 MPa	115 MPa	100 MPa	348 MPa	695 MPa
Flexural Strength	540 MPa	393 MPa	200 MPa	170 MPa	1200 MPa	600 MPa
Tensile Elongation	2%	2.7%	4.4%	20%	-	8%
Flexural Modulus	26 GPa	18.8 GPa	5.0 GPa	4.0 GPa	210 GPa	175 GPa
Compressive Strength	530 MPa	347 MPa	246 MPa	118 MPa	2000 MPa	448 MPa

## CLINICAL SPECIALTIES

**Chairside®:** pink dual-cure Bis-Acryl chairside attachment pickup material, odorless and tasteless. Working time 2 minutes and 15 seconds, curing time 7 minutes (self cure). 4mL syringe enables the pickup of about 30 attachments

Clinical Specialties

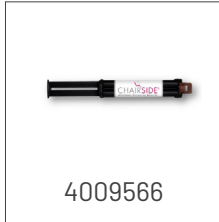

### Clinical Specialties

Item #	Product
4009566	CHAIRSIDE Pickup Material 4mL Syringe and Plunger, 15 Mixing Tips, 15 Angled Tips
4009565	CHAIRSIDE Pickup Material 18mL Syringe and Plunger, 10 Mixing Tips, 10 Angled Tips <i>Low viscosity provides excellent control during chairside pickup. Ideal for picking up Temporary Cylinders in hybrid dentures.</i> <b>Optimal handling characteristics:</b> <ul style="list-style-type: none"> <li>• Tissue-colored material bonds to itself.</li> <li>• Dual cure - self or light cure.</li> <li>• Will set in approximately 5 minutes. The working time is approximately 2 minutes and 15 seconds.</li> <li>• The material will self cure in approximately 7 minutes. Curing time can be shortened by light curing.</li> </ul>
4009125-15	CHAIRSIDE Short Mixing Tips (15-Pack)
4009549	Denture Removal Tool (10-Pack)
4009574	CHAIRSIDE Block Out Material-4 Syringes (1.2mL), 20 Mixing Tips <i>A soft, light-cured resin material designed to protect a patient's tissue from undercuts during the chairside overdenture processing. The optimal handling and low viscosity ensure precise application and easy removal, while the contrasting blue pigment provides better visibility during clinical procedures</i>

**Perma Ret:** a simple solution for Permanent Retention of acrylic and composite denture teeth in both full and partial dentures. Simply drill a small hole in the tooth with the provided twist drill. Cut a length of wire and insert in the wire holder. Thread the wire into the tooth. Bend the wire into desired position. Then process the denture base material. Wire is now anodized for improved esthetics.



Perma Ret



0109000



0109002



Perma Ret

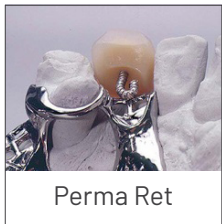

Perma Ret



6000005

Perma Ret	
Item #	Product
0109000	Perma Ret Kit 3 twist drills, 1 wire holder, and 13 pieces of 80mm long threaded silver wire
0109002	Perma Ret Wire Refill 13 pieces of 80mm long threaded silver wire
0109002-6	Perma Ret Wire Refill (6-Pack)
0109004	Perma Ret Twist Drills (3)
0109006	Perma Ret Tool
6000005	Denture Stippling Mandrel <i>The 1/4 inch shaft will fit most standard chucks on a dental lathe. The user should place 4 of either a #2, #4, or #6 round straight handpiece or FG steel or carbide burs into the stippling mandrel and tighten securely with the Allen wrench that is included with the stippling mandrel. Best results are achieved using dull or used burs. *Burs are not included with the mandrel*</i>

Perma Ret

65

**Pro Blue:** The finest single step polishing compound available. Water soluble for easy cleaning and a high shine on acrylic, composites, thermoplastics, and all alloys.



0601251

Pro Blue NTR Polish	
Item #	Product
0601251	Pro Blue NTR Polishing Compound 150g

Pro Blue NTR Polish

# ATTACHMENTS

## CAD-CAM BAR SOLUTIONS

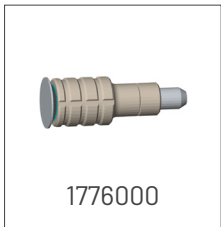
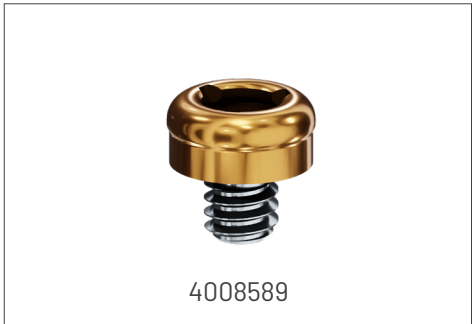

### CAD-CAM Bar Solutions

Item #	Product
4008589-2	LOCATOR Bar Female threaded 2mm (2-Pack)
4008589-10	LOCATOR Bar Female threaded 2mm (10-Pack)
4008028-2	LOCATOR Bar Processing Package (2-Pack)
4008028-10	LOCATOR Bar Processing Package (10-Pack)
0101702	Milled Hader Bar Attachment
1776000	Universal Plunger Loc Attachment
0101274	Universal Threaded Ball 2.2mm <i>Based on the universally accepted thread: M2 x .040 Our existing drill (4009102) and tap (4009104) may be used with the Universal Threaded Ball.</i>
0101380	Milled Bar Sagix Complete Attachment
0101280	Milled Bar Clix Complete Attachment
2339SFE	OT Equator Threaded 1.6mm Abutment
239SFE2	OT Equator Threaded 2mm Abutment
2239GSF	OT Equator 1.6mm Threaded Sleeve

## ALLOY CHART

ALLOY CHART	
<b>PALLAX</b>	<b>STAINLESS STEEL</b>
White - Au 2 - Ag 37 - Pt 9.5 - Pd 37 - Cu 12.5 - Co 2	White - Fe 66 - Cr 17 - Ni 11 -
Melting range: 1055-1130 °C (1931-2066 °F)	Mo 2 - other 4 - Do not heat!
<b>IRAX - Precious</b>	<b>POLYPROPYLENE</b>
White - Au 60 - Pt 24 - Pd 15 - Ir 1	Hader Clips
Melting range: 1400-1460 °C (2552-2660 °F)	
<b>NOPRAX - Non-precious</b>	<b>POLYPROPYLENE</b>
White - Au 2 - Ag 37 - Pt 9.5 - Pd 37 - Cu 12.5 - Co 2	Clix, Sagix Females
Melting range: 1055-1130 °C (1931-2066 °F)	
<b>ORAX</b>	<b>THERMOPLASTIC ELASTOMER</b>
Yellow - Au 67 - Pt 8.6 - Ag 13.2 - Cu 11 - Zn 0.Y 2	# 1201 B
Melting range: 910-995 °C (1670-1823°F)	
Heat treatment: 60 min at 400 °C (752 °F)	
<b>PLATIRAX</b>	<b>TITANAX</b>
White - Pt 85 - Ir 15	White - Ti 90 - Al 6 - V 4 - Do not heat!
Melting range: 1790-1820 °C (3254-3308°F)	

# Restoring Confidence.

## PREAT ABUTMENTS

will meet and/or exceed fit and function of the OEM abutments\*

- » OEM Implant Warranty Matched
- » Manufactured in the US
- » Lifecycle Product and Technical Support



## SAMPLE TESTING RESULT

### MATING FEATURE 1

Screw head clearance to the abutment

### MATING FEATURE 2

Screw shaft clearance to the abutment

### MATING FEATURE 3

Hexagonal connection clearance

### MATING FEATURE 4

Abutment tapered seat

### MATING FEATURE 5

Abutment hexagonal clearance to the implant

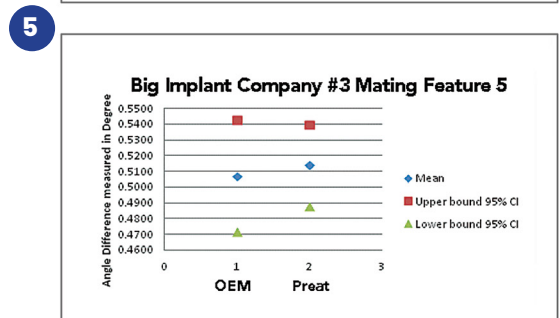
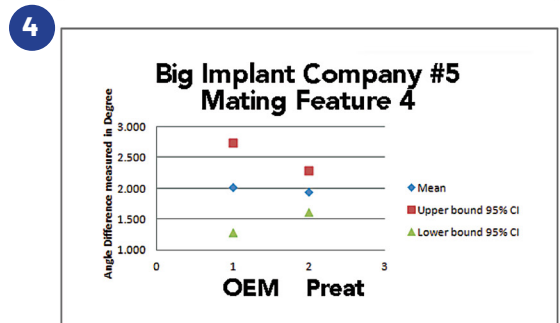
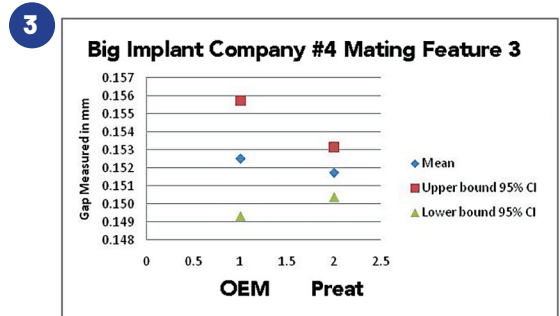
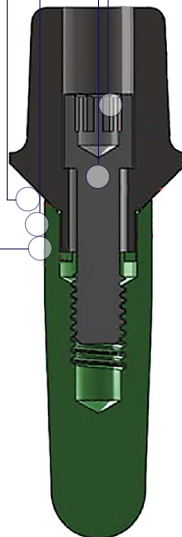
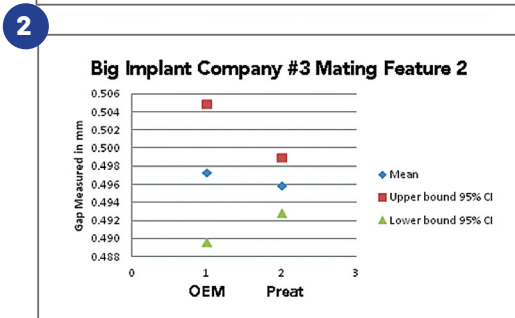
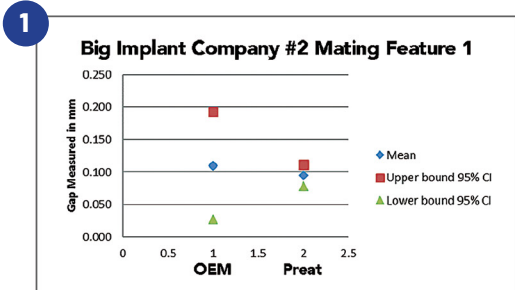

\*Test results by independant third party, 2018



# IMPLANT PROSTHETICS

## Preat **CHOICE** **LIBRARY**

We've expanded the Preat Choice Library to give you even more implant system choices. With these additions, the Preat Choice Library is compatible with all major implant systems – **40 platforms in total**.

For each system platform, the scan body gives you access to 18 different restorative options, including engaging and non-engaging, for fixture-level restorations.

- » **ANGLED SCREW CHANNEL (ASC) TITANIUM BASES** designed for optimal esthetics and function with 0° to 30° channel angulation, cement groove to prevent overflow, plus retention grooves and blasted surface for enhanced cement adhesion
- » **STRAIGHT TITANIUM BASES** for digital or traditional workflow
- » **VERIFICATION CYLINDERS** for provisional restorations with variable height options
- » **PLUS 9 DIFFERENT RESTORATIVE SOLUTIONS** for full arch cases
- » **PATIENT-SPECIFIC ABUTMENTS** tailored to your patients' needs, offering up to 30° of angulation



# Quick Reference Chart

Manufacturer	Compatible Implant/ Interface	Healing Abutment	Scan Body	Transfer	Digital Analog <sup>2</sup>	Analog <sup>3</sup>	Verification Cylinder		Patient- Specific Abutment	ASC Ti Base	
							Engaging	Non- Engaging		Titanium	Engaging
BioHorizons®	Tapered Internal 3.0mm		✓		✓	✓			✓		
	Tapered Internal 3.5mm	*	✓	*	✓	✓	*	*	✓	*See Zimmer Tapered Screw-Vent® 3.5mm	
	Tapered Internal 4.5mm	**	✓	**	✓	✓	**	**	✓	**See Zimmer Tapered Screw-Vent® 4.5mm	
Branemark®	RP 3.75/4.1mm		✓			✓	✓				
CAMLOG®	Screw-Line 3.3mm		✓			✓	✓	✓			
	Screw-Line 3.8mm		✓			✓	✓	✓			
	Screw-Line 4.3mm		✓			✓	✓	✓			
	Screw-Line 5.0mm		✓			✓	✓	✓			
	Screw-Line 6.0mm		✓			✓	✓	✓			
Dentsply Sirona	Ankylos®		✓			✓	✓				
	Astra TX 3.0mm		✓		✓	✓	✓	✓			
	Astra TX Aqua 3.5/4.0mm	✓	✓	✓	✓	✓	✓	✓			
	Astra TX Lilac 4.5/5.0mm	✓	✓	✓	✓	✓	✓	✓			
	Astra Tech EV 3.0mm	✓	✓	✓	✓	✓	✓	✓	✓		✓
	Astra Tech EV 3.6mm	✓	✓	✓	✓	✓	✓	✓	✓		✓
	Astra Tech EV 4.2mm	✓	✓	✓	✓	✓	✓	✓	✓		✓
	Astra Tech EV 4.8mm	✓	✓	✓	✓	✓	✓	✓	✓		✓
Astra Tech EV 5.4mm	✓	✓	✓	✓	✓	✓	✓	✓		✓	
Hiossen®	Mini	✓	✓	✓	✓	✓	✓	✓	✓		✓
	Regular	✓	✓	✓	✓	✓	✓	✓	✓		✓
Implant Direct	Legacy™ 3.0mm		✓		✓	✓			✓		
	Legacy™ 3.5mm	*	✓	*	✓	✓	*	*	✓	*See Zimmer Tapered Screw-Vent® 3.5mm	
	Legacy™ 4.5mm	**	✓	**	✓	✓	**	**	✓	**See Zimmer Tapered Screw-Vent® 4.5mm	
	Legacy™ 5.7mm	***	✓	***	✓	✓	***	***	✓	***See Zimmer Tapered Screw-Vent® 5.7mm	
Keystone Dental	PrimaConnex™ TiLobe® 3.5mm	✓	✓	✓	✓	✓	✓	✓	✓	✓	✓
	PrimaConnex™ TiLobe® 4.1mm	✓	✓	✓	✓	✓	✓	✓	✓	✓	✓
	PrimaConnex™ TiLobe® 5.0mm	✓	✓	✓	✓	✓	✓	✓	✓	✓	✓
MegaGen	AnyRidge®	✓	✓	✓	✓	✓	✓	✓	✓		✓
Multi-Unit		✓	✓	✓	✓	✓	N/A	✓	N/A	N/A	✓
Neodent®	Helix GM™	✓	✓	✓	✓	✓	✓	✓	✓	✓	✓
Neoss®	Regular Platform 3.5/4.0/4.5/5.0/5.5mm		✓		✓	✓			✓		
NobelBiocare™	NobelActive™ 3.0mm	✓	✓	✓	✓	✓	✓	✓	✓	✓	✓
	NobelActive™ NP	✓	✓	✓	✓	✓	✓	✓	✓	✓	✓
	NobelActive™ RP	✓	✓	✓	✓	✓	✓	✓	✓	✓	✓
	NobelActive™ WP		✓	✓	✓	✓	✓	✓	✓		
	Tri-Lobe NP		✓	✓	✓	✓	✓	✓	✓	✓	✓
	Tri-Lobe RP		✓	✓	✓	✓	✓	✓	✓	✓	✓
	Tri-Lobe WP		✓	✓	✓	✓	✓	✓	✓		
	Tri-Lobe 6.0mm		✓		✓	✓	✓	✓	✓		
Straumann®	BLX RB/WB	✓	✓	✓	✓	✓	✓	✓	✓	✓	✓
	BLX WB	✓	✓	✓	✓	✓	✓	✓	✓	✓	✓
	Bone Level NC	✓	✓	✓	✓	✓	✓	✓	✓	✓	✓
	Bone Level RC	✓	✓	✓	✓	✓	✓	✓	✓	✓	✓
	Tissue Level NN 3.5mm					✓					
	Tissue Level RN 4.8mm		✓		✓	✓	✓	✓	✓	✓	✓
	Tissue Level WN 6.5mm		✓		✓	✓	✓	✓	✓		
ZimVie (formerly Zimmer Dental)	Certain® 3.4mm		✓		✓	✓	✓	✓	✓	✓	✓
	Certain® 4.1mm		✓		✓	✓	✓	✓	✓	✓	✓
	Certain® 5.0mm		✓	Call	✓	✓	✓	✓	✓		
	Certain® 6.0mm		✓	Call	✓	✓	✓	✓	✓		
	Tapered Screw-Vent® 3.5mm	✓	✓	✓	✓	✓	✓	✓	✓	✓	✓
	Tapered Screw-Vent® 4.5mm	✓	✓	✓	✓	✓	✓	✓	✓	✓	✓
	Tapered Screw-Vent® 5.7mm		✓		✓	✓	✓	✓	✓	✓	✓

# Quick Reference Chart *(cont'd)*

Manufacturer	Compatible Implant/ Interface	Ti Base			Multi-Unit Abutment			Esthetic Abutment		Gold/Plastic UCLA		Plastic UCLA	
		Engaging	6mm Engaging	Non-Engaging	Straight	17°	30°	Straight	15°	Engaging	Non-Engaging	Engaging	Non-Engaging
BioHorizons®	Tapered Internal 3.0mm												
	Tapered Internal 3.5mm	*See Zimmer Tapered Screw-Vent® 3.5mm											
	Tapered Internal 4.5mm	**See Zimmer Tapered Screw-Vent® 4.5mm											
Branemark®	RP 3.75/4.1mm	✓	✓	✓	✓	✓	✓					✓	✓
CAMLOG®	Screw-Line 3.3mm	✓	✓	✓	✓	✓	✓	✓	✓				✓
	Screw-Line 3.8mm	✓	✓	✓	✓	✓	✓	✓	✓				✓
	Screw-Line 4.3mm	✓	✓	✓	✓	✓	✓	✓	✓				✓
	Screw-Line 5.0mm	✓	✓	✓	✓	✓	✓	✓	✓				✓
	Screw-Line 6.0mm	✓	✓	✓	✓	✓	✓	✓	✓				✓
Dentsply Sirona	Ankylos®	✓	✓	✓	✓			✓	✓				✓
	Astra TX 3.0mm	✓	✓					✓	✓			✓	✓
	Astra TX Aqua 3.5/4.0mm	✓	✓	✓	✓	✓	✓	✓	✓			✓	✓
	Astra TX Lilac 4.5/5.0mm	✓	✓	✓	✓	✓	✓	✓	✓			✓	✓
	Astra Tech EV 3.0mm	✓	✓	✓									
	Astra Tech EV 3.6mm	✓	✓	✓									
	Astra Tech EV 4.2mm	✓	✓	✓									
	Astra Tech EV 4.8mm	✓	✓	✓									
	Astra Tech EV 5.4mm	✓	✓	✓									
Hiossen®	Mini	✓	✓	✓	✓	✓	✓	✓	✓			✓	✓
	Regular	✓	✓	✓	✓	✓	✓	✓	✓			✓	✓
Implant Direct	Legacy™ 3.0mm												
	Legacy™ 3.5mm	*See Zimmer Tapered Screw-Vent® 3.5mm											
	Legacy™ 4.5mm	**See Zimmer Tapered Screw-Vent® 4.5mm											
	Legacy™ 5.7mm	***See Zimmer Tapered Screw-Vent® 5.7mm											
Keystone Dental	PrimaConnex™ TiLobe® 3.5mm	✓	✓	✓									
	PrimaConnex™ TiLobe® 4.1mm	✓	✓	✓									
	PrimaConnex™ TiLobe® 5.0mm	✓	✓	✓									
MegaGen	AnyRidge®	✓	✓	✓	✓	✓	✓	✓	✓			✓	✓
Multi-Unit		N/A	N/A	✓	N/A	N/A	N/A	N/A	N/A	N/A	✓	N/A	N/A
Neodent®	Helix GM™	✓	✓	✓									
Neoss®	Regular Platform 3.5/4.0/4.5/5.0/5.5mm												
NobelBiocare™	NobelActive™ 3.0mm	✓	✓	✓	✓			✓	✓	✓	✓	✓	✓
	NobelActive™ NP	✓	✓	✓	✓	✓	✓	✓	✓	✓	✓	✓	✓
	NobelActive™ RP	✓	✓	✓	✓	✓	✓	✓	✓	✓	✓	✓	✓
	NobelActive™ WP	✓	✓	✓				✓		✓	✓	✓	✓
	Tri-Lobe NP	✓	✓	✓	✓	✓		✓	✓	✓	✓	✓	✓
	Tri-Lobe RP	✓	✓	✓	✓	✓	✓	✓	✓	✓	✓	✓	✓
	Tri-Lobe WP	✓	✓	✓	✓			✓	✓	✓	✓	✓	✓
	Tri-Lobe 6.0mm	✓	✓	✓				✓		✓		✓	✓
Straumann®	BLX RB/WB	✓	✓	✓									
	BLX WB	✓	✓	✓									
	Bone Level NC	✓	✓	✓	✓	✓		✓	✓			✓	✓
	Bone Level RC	✓	✓	✓	✓	✓	✓	✓	✓			✓	✓
	Tissue Level NN 3.5mm												
	Tissue Level RN 4.8mm	✓	✓	✓						✓	✓		
	Tissue Level WN 6.5mm	✓	✓	✓						✓	✓		
ZimVie (formerly Zimmer Dental)	Certain® 3.4mm	✓	✓	✓	✓	✓		✓	✓			✓	✓
	Certain® 4.1mm	✓	✓	✓	✓	✓	✓	✓	✓			✓	✓
	Certain® 5.0mm	✓	✓	✓	✓	✓		✓	✓			✓	✓
	Certain® 6.0mm	✓	✓	✓				✓				✓	✓
	Tapered Screw-Vent® 3.5mm	✓	✓	✓	✓	✓	✓	✓	✓	✓		✓	✓
	Tapered Screw-Vent® 4.5mm	✓	✓	✓	✓	✓	✓	✓	✓	✓		✓	✓
	Tapered Screw-Vent® 5.7mm	✓	✓	✓								✓	✓

# IMPLANT PROSTHETICS

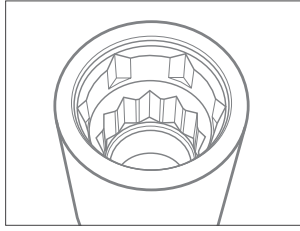

Compatible with  
**3i Certain®**

## 3i Certain® 3.4mm Compatible

Item #	Product
9001645	3.4mm Preat Choice Titanium Scan Body
9001600	3.4mm Analog
9001600-10	3.4mm Analog (10-Pack)
9001600-25	3.4mm Analog (25-Pack)
9001603	3.4mm Digital Analog
9001603-10	3.4mm Digital Analog (10-Pack)
9001630	3.4mm Engaging Verification Cylinder
9001630-10	3.4mm Engaging Verification Cylinder (10-Pack)
9001635	3.4mm Non-Engaging Verification Cylinder
9001635-10	3.4mm Non-Engaging Verification Cylinder (10-Pack)
9001690	ASC 3.4mm x 9mm Engaging Ti Base
9001795	ASC 3.4mm x 9mm Non-Engaging Ti Base
9001653	ASC 3.4mm/4.1mm/5.0mm/6.00mm Titanium Screw



9001645



9001600



9001603



9001630



9001635



9001690



9001795

3i® Certain 3.4mm Compatible

72

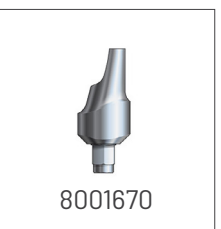

## 3i Certain® 3.4mm Compatible (cont'd)

Item #	Product
9001659	3.4mm Non-Engaging Ti Base x 4.5mm
9001661	3.4mm Engaging Ti Base x 4.5mm
9001662	3.4mm Engaging Ti Base x 6mm
9001650	<u>3.4mm / 4.1mm / 5.0mm / 6.0mm</u> Titanium Screw
9001650-10	<u>3.4mm / 4.1mm / 5.0mm / 6.0mm</u> Titanium Screw (10-Pack)
9001651	<u>3.4mm / 4.1mm / 5.0mm / 6.0mm</u> Guide Pin 20mm
8001789	<u>3.4mm / 4.1mm / 5.0mm / 6.0mm</u> Multi-Unit Titanium Screw
8001680	3.4mm 17° Multi-Unit Abutment x 2mm
8001681	3.4mm 17° Multi-Unit Abutment x 3mm
8001675	3.4mm Straight Multi-Unit Abutment x 1mm
8001676	3.4mm Straight Multi-Unit Abutment x 2mm
8001677	3.4mm Straight Multi-Unit Abutment x 3mm
8001670	3.4mm Esthetic Abutment 15° Angle, Anterior
8001671	3.4mm Esthetic Abutment Straight, Anterior
8001610	3.4mm Engaging Plastic UCLA
8001615	3.4mm Non-Engaging Plastic UCLA
9001667	3.4mm 3i Certain®-compatible Titanium Blank
9001665	3.4mm ASC 3i Certain®-compatible Titanium Blank

# IMPLANT PROSTHETICS

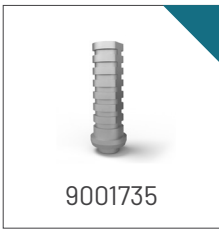

## 3i Certain® 4.1mm

Item #	Product
9001745	4.1mm Preat Choice Titanium Scan Body
9001700	4.1mm Analog
9001700-10	4.1mm Analog (10-Pack)
9001700-25	4.1mm Analog (25-Pack)
9001703	4.1mm Digital Analog
9001703-10	4.1mm Digital Analog (10-Pack)
9001730	4.1mm Engaging Verification Cylinder
9001730-10	4.1mm Engaging Verification Cylinder (10-Pack)
9001735	4.1mm Non-Engaging Verification Cylinder
9001735-10	4.1mm Non-Engaging Verification Cylinder (10-Pack)
9001790	ASC 4.1mm x 9mm Engaging Ti Base
9001795	ASC 4.1mm x 9mm Non-Engaging Ti Base
9001759	4.1 mm Non-Engaging Ti Base x 4.5mm
9001761	4.1 mm Engaging Ti Base x 4.5mm
9001762	4.1mm Engaging Ti Base x 6.0mm

3i Certain® 4.1mm Compatible

74

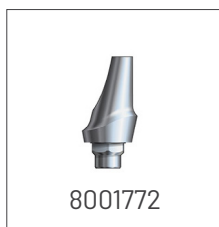
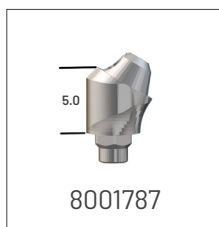
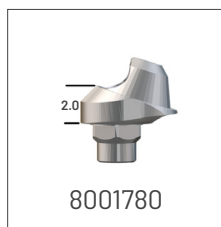
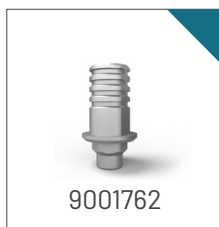

## 3i Certain® 4.1mm (cont'd)

Item #	Product
	3i® Screws and Guide Pins - <a href="#">See page 73</a>
8001780	4.1mm 17° Multi-Unit Abutment x 2mm
8001781	4.1mm 17° Multi-Unit Abutment x 3mm
8001786	4.1mm 30° Multi-Unit Abutment x 4mm
8001787	4.1mm 30° Multi-Unit Abutment x 5mm
8001775	4.1mm Straight Multi-Unit Abutment x 1mm
8001776	4.1mm Straight Multi-Unit Abutment x 2mm
8001777	4.1mm Straight Multi-Unit Abutment x 3mm
8001779	4.1mm Straight Multi-Unit Abutment x 5mm
8001770	4.1mm Esthetic Abutment 15° Angle, Anterior
8001772	4.1mm Esthetic Abutment 15° Angle, Posterior
8001771	4.1mm Esthetic Abutment Straight, Anterior
8001773	4.1mm Esthetic Abutment Straight, Posterior
8001710	4.1mm Engaging Plastic UCLA
8001715	4.1mm Non-Engaging Plastic UCLA
9001765	4.1mm ASC 3i Certain®-compatible Titanium Blank
9001767	4.1mm 3i Certain®-compatible Titanium Blank

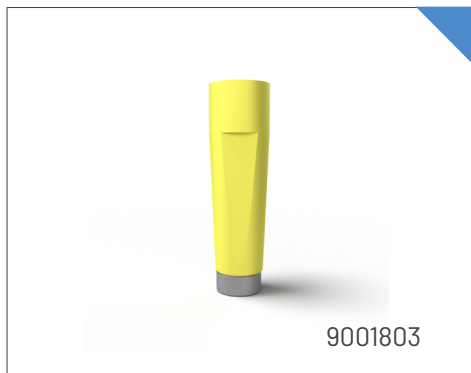
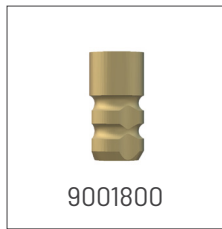

3i° Certain 5.0mm Compatible

## 3i° Certain 5.0mm

Item #	Product
8001841	5.0mm Titanium Scan Body <i>(for use with Ti Bases)</i>
9001845	5.0mm Preat Choice Titanium Scan Body <i>(for Preat Custom Solutions)</i>
9001800	5.0mm Analog
9001800-10	5.0mm Analog (10-Pack)
9001800-25	5.0mm Analog (25-Pack)
9001803	5.0mm Digital Analog
9001803-10	5.0mm Digital Analog (10-Pack)
9001835	5.0mm Non-Engaging Verification Cylinder
9001835-10	5.0mm Non-Engaging Verification Cylinder (10-Pack)
9001830	5.0mm Engaging Verification Cylinder
9001830-10	5.0mm Engaging Verification Cylinder (10-Pack)
8001859	5.0mm Non-Engaging Ti Base x 4.5mm
8001861	5.0mm Engaging Ti Base x 4.5mm
8001862	5.0mm Engaging Ti Base x 6mm
	Screws and Guide Pins - <a href="#">See page 69</a>
8001880	5.0mm 17° Multi-Unit Abutment x 2mm
8001881	5.0mm 17° Multi-Unit Abutment x 3mm
8001875	5.0mm Straight Multi-Unit Abutment x 1mm
8001876	5.0mm Straight Multi-Unit Abutment x 2mm

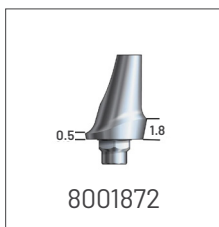
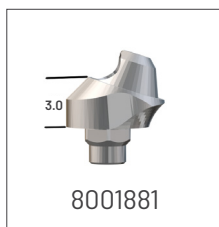
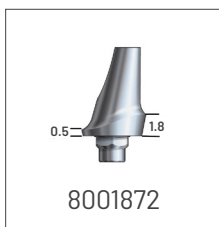
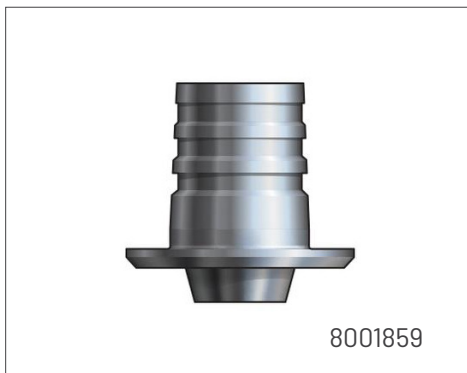

## 3i<sup>®</sup> Certain 5.0mm (cont'd)

Item #	Product
8001877	5.0mm Straight Multi-Unit Abutment x 3mm
8001870	5.0mm Esthetic Abutment 15° Angle, Anterior
8001872	5.0mm Esthetic Abutment 15° Angle, Posterior
8001871	5.0mm Esthetic Abutment Straight, Anterior
8001873	5.0mm Esthetic Abutment Straight, Posterior
8001810	5.0mm Engaging Plastic UCLA
8001815	5.0mm Non-Engaging Plastic UCLA
9001865	5.0mm ASC 3i Certain <sup>®</sup> -compatible Titanium Blank
9001867	5.0mm 3i Certain <sup>®</sup> -compatible Titanium Blank

# IMPLANT PROSTHETICS

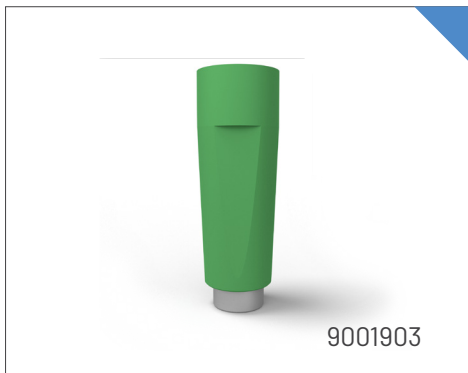
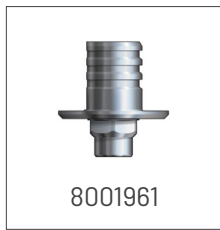
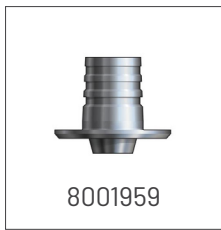

## 3i® Certain 6.0mm

Item #	Product
8001941	6.0mm Scan Body <i>(for use with Ti Bases)</i>
9001945	6.0mm Preat Choice Titanium Scan Body <i>(for Preat Custom Solutions)</i>
9001900	6.0mm Analog
9001900-10	6.0mm Analog (10-Pack)
9001900-25	6.0mm Analog (25-Pack)
9001903	6.0mm Digital Analog
9001903-10	6.0mm Digital Analog (10-Pack)
8001930	6.0mm Engaging Verification Cylinder
8001935	6.0mm Non-Engaging Verification Cylinder
8001959	6.0 mm Non-Engaging Ti Base x 4.5mm
8001961	6.0 mm Engaging Ti Base x 4.5mm
8001962	6.0mm Engaging Ti Base x 6mm
	Screws and Guide Pins - <a href="#">See page 69</a>
8001973	6.0mm Esthetic Abutment Straight, Posterior
8001910	6.0mm Engaging Plastic UCLA
8001915	6.0mm Non-Engaging Plastic UCLA
9001965	6.0mm ASC 3i Certain®-compatible Titanium Blank
9001967	6.0mm 3i Certain®-compatible Titanium Blank

3i® Certain 6.0mm Compatible

78

## 3i® External Hex

3i External Hex 3.75 / 4.0mm	<i>Please see Nobel Branemark RP</i>
------------------------------	--------------------------------------

## Ace Surgical Implant Systems

ACE Infinity Internal 3.7 / 4.1 (3.5mmD)	<i>Please see Zimmer TSV 3.5mm</i>
ACE Infinity Internal 4.7 / 5.1 (4.5mmD)	<i>Please see Zimmer TSV 4.5mm</i>
ACE Infinity TRI-CAM 3.5mm	<i>Please see Nobel Tri-Lobe NP</i>
ACE Infinity TRI-CAM 4.3mm	<i>Please see Nobel Tri-Lobe RP</i>
ACE Infinity TRI-CAM 5.0mm	<i>Please see Nobel Tri-Lobe WP</i>
ACE Infinity X-hex 3.7 / 4.0	<i>Please see Nobel Branemark RP</i>
ACE Infinity X-hex 4.75	<i>Please see Nobel Branemark WP</i>
ACE Octagon Bone Level 3.3mm	<i>Please see Nobel Active / Conical NP</i>
ACE Octagon Bone Level 4.1mm	<i>Please see Nobel Active / Conical RP</i>

# IMPLANT PROSTHETICS

Ankylos® C/X (indexed) & C (non-indexed) Implant 3.5 / 4.5 / 5.5mm Compatible

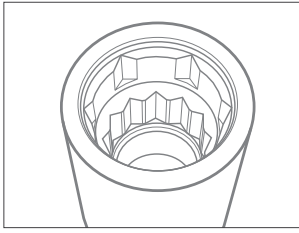

Compatible with  
Dentsply Ankylos®

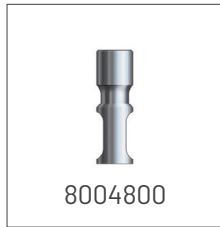

## Ankylos® C/X (indexed) & C (non-indexed) Implant 3.5 / 4.5 / 5.5mm

Item #	Product
8004841	Titanium Scan Body <i>(for use with Ti Bases)</i>
8004800	3.5mm Analog
8004800-10	3.5mm Analog (10-Pack)
8004805	4.5mm Analog
8004805-10	4.5mm Analog (10-Pack)
8004806	5.5mm Analog
8004806-10	5.5mm Analog (10-Pack)
8004806-25	5.5mm Analog (25-Pack)
8004861	3.5mm Engaging Ti Base x 4.5mm
8004857	3.5mm Non-Engaging Ti Base x 4.5mm
8004863	3.5mm Engaging Ti Base x 6mm
8004858	4.5mm Non-Engaging Ti Base x 4.5mm
8004859	5.5mm Non-Engaging Ti Base x 4.5mm
8004851	Guide Pin

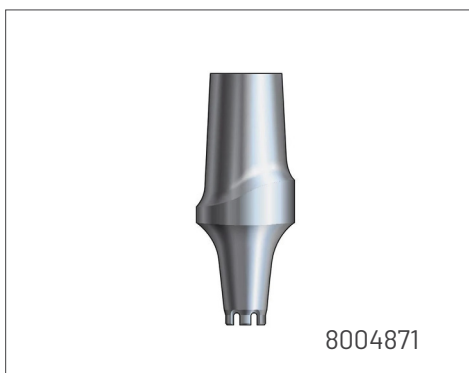
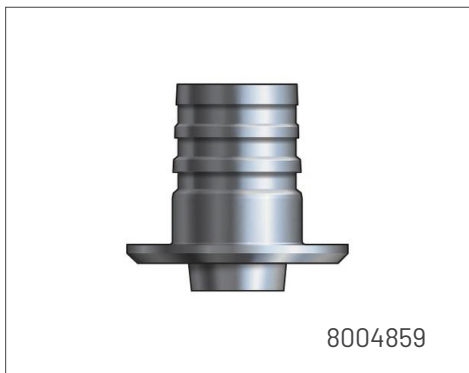

## Ankylos® C/X (indexed) & C (non-indexed) Implant 3.5 / 4.5 / 5.5mm

Item #	Product
8004850	Titanium Screw
8004875	Straight Multi-Unit Abutment x 1.5mm
8004876	Straight Multi-Unit Abutment x 2.5mm
8004877	Straight Multi-Unit Abutment x 3.5mm
8004878	Straight Multi-Unit Abutment x 4.5mm
8004870	Esthetic Abutment 15° Angle, Anterior
8004872	Esthetic Abutment 15° Angle, Posterior
8004871	Esthetic Abutment Straight, Anterior
8004873	Esthetic Abutment Straight, Posterior
8004830	Engaging Verification Cylinder
8004835	Non- Engaging Verification Cylinder
8004815	Non-Engaging Plastic UCLA

Ankylos® C/X (indexed) & C (non-indexed) Implant 3.5 / 4.5 / 5.5mm Compatible

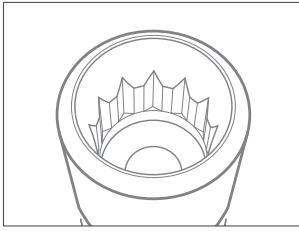

Compatible with  
Astra® TX



8002030



9002000



8002061



8002062



8002050



8002051



8002070



8002071



8002015



9002067

## Astra® 3.0mm

Item #	Product
8002041	3.0mm Titanium Scan Body <i>(for use with Ti Bases)</i>
9002045	3.0mm Preat Choice Titanium Scan Body <i>(for Preat Custom Solutions)</i>
9002000	3.0mm Analog
9002000-10	3.0mm Analog (10-Pack)
9002000-25	3.0mm Analog (25-Pack)
9002003	3.0mm Digital Analog
9002003-10	3.0mm Digital Analog (10-Pack)
8002030	3.0mm Engaging Verification Cylinder
8002030-10	3.0mm Engaging Verification Cylinder (10-Pack)
8002061	3.0mm Engaging Ti Base x 4.5mm
8002062	3.0mm Engaging Ti Base x 6mm
8002050	3.0mm Titanium Screw
9002053	ASC 3.0mm Titanium Screw
8002050-10	3.0mm Titanium Screw (10-Pack)
8002051	3.0mm Guide Pin 20mm
8002070	3.0mm Esthetic Abutment 15° Angle, Anterior
8002071	3.0mm Esthetic Abutment Straight, Anterior
8002010	3.0mm Engaging Plastic UCLA
8002015	3.0mm Non-Engaging Plastic UCLA
9002065	3.0mm ASC Astra®-compatible Titanium Blank
9002067	3.0mm Astra®-compatible Titanium Blank



Astra® Aqua 3.5 / 4.0mm	
Item #	Product
8002123	3.5 / 4.0mm Healing Abutment 4 x 5mm
8002104	3.5 / 4.0mm Closed Tray Impression Tray Coping 3.8 x 9mm
8002141	3.5 / 4.0mm Titanium Scan Body <i>(for use with Ti Bases)</i>
9002145	3.5 / 4.0mm Preat Choice Titanium Scan Body <i>(for Preat Custom Solutions)</i>
9002100	3.5 / 4.0mm Analog
9002100-10	3.5 / 4.0mm Analog (10-Pack)
9002100-25	3.5 / 4.0mm Analog (25-Pack)
9002103	3.5/4.0mm Digital Analog
9002103-10	3.5/4.0mm Digital Analog (10-Pack)
8002130	3.5 / 4.0mm Engaging Verification Cylinder
8002130-10	3.5 / 4.0mm Engaging Verification Cylinder (10-Pack)
8002135	3.5 / 4.0mm Non-Engaging Verification Cylinder
8002135-10	3.4 / 4.0mm Non-Engaging Verification Cylinder (10-Pack)
8002159	3.5 / 4.0mm Non-Engaging Ti Base x 4.5mm
8002161	3.5 / 4.0mm Engaging Ti Base x 4.5mm
8002162	3.5 / 4.0mm Engaging Ti Base x 6mm
8002150	3.5 / 4.0mm Titanium Screw
9002153	ASC Aqua 3.5mm/5.0mm Titanium Screw
8002151	3.5 / 4.0mm Guide Pin 20mm
8002189	3.5 / 4.0mm Multi-Unit Titanium Screw
8002175	3.5 / 4.0mm Straight Multi-Unit Abutment x 1.5mm

Astra® Aqua 3.5 / 4.0mm Compatible

# IMPLANT PROSTHETICS

Astra® Aqua 3.5 / 4.0mm Compatible

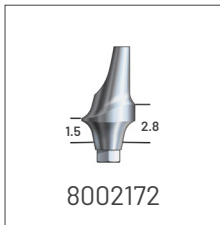

## Astra® Aqua 3.5 / 4.0mm (cont'd)

Item #	Product
8002176	3.5 / 4.0mm Straight Multi-Unit Abutment x 2.5mm
8002177	3.5 / 4.0mm Straight Multi-Unit Abutment x 3.5mm
8002180	3.5 / 4.0mm 17° Multi-Unit Abutment x 2.5mm
8002181	3.5 / 4.0mm 17° Multi-Unit Abutment x 3.5mm
8002185	3.5 / 4.0mm 30° Multi-Unit Abutment x 3.5mm
8002186	3.5 / 4.0mm 30° Multi-Unit Abutment x 4.5mm
8002170	3.5 / 4.0mm Esthetic Abutment 15° Angle, Anterior
8002172	3.5 / 4.0mm Esthetic Abutment 15° Angle, Posterior
8002171	3.5 / 4.0mm Esthetic Abutment Straight, Anterior
8002173	3.5 / 4.0mm Esthetic Abutment Straight, Posterior
8002110	3.5 / 4.0mm Engaging Plastic UCLA
8002115	3.5 / 4.0mm Non-Engaging Plastic UCLA
9002165	3.5/4.0mm ASC Astra®-compatible Aqua Titanium Blank
9002167	3.5/4.0mm Astra®-compatible Aqua Titanium Blank

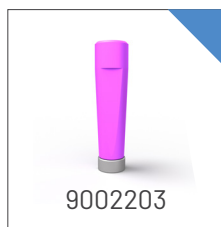

Astra® Lilac 4.5 / 5.0mm	
Item #	Product
8002223	4.5 / 5.0mm Healing Abutment 5 x 5mm
8002204	4.5 / 5.0mm Closed Tray Impression Tray Coping 4.5 x 9mm
8002241	4.5 / 5.0mm Titanium Scan Body <i>(for use with Ti Bases)</i>
9002245	4.5 / 5.0mm Preat Choice Titanium Scan Body <i>(for Preat Custom Solutions)</i>
9002200	4.5 / 5.0mm Analog
9002200-10	4.5 / 5.0mm Analog (10-Pack)
9002200-25	4.5 / 5.0mm Analog (25-Pack)
9002203	4.5 / 5.0mm Digital Analog
9002203-10	4.5 / 5.0mm Digital Analog (10-Pack)
8002230	4.5 / 5.0mm Engaging Verification Cylinder
8002230-10	4.5 / 5.0mm Engaging Verification Cylinder (10-Pack)
8002235	4.5 / 5.0mm Non-Engaging Verification Cylinder
8002235-10	4.5 / 5.0mm Non-Engaging Verification Cylinder (10-Pack)
8002259	4.5 / 5.0mm Non-Engaging Ti Base x 4.5mm
8002261	4.5 / 5.0mm Engaging Ti Base x 4.5mm
8002262	4.5 / 5.0mm Engaging Ti Base x 6mm
8002250	4.5 / 5.0mm Titanium Screw
8002250-10	4.5 / 5.0mm Titanium Screw (10-Pack)
9002253	ASC Lilac 4.5mm/6.0mm Titanium Screw
8002251	4.5 / 5.0mm Guide Pin 20mm
8002289	4.5 / 5.0mm Multi-Unit Titanium Screw
8002280	4.5 / 5.0mm 17° Multi-Unit Abutment x 2.5mm

Astra® Lilac 4.5 / 5.0mm Compatible

# IMPLANT PROSTHETICS

Astra® Lilac 4.5 / 5.0mm Compatible

86

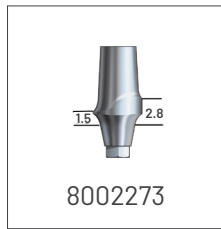
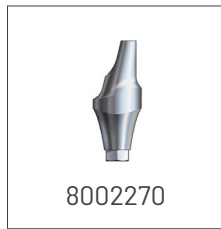
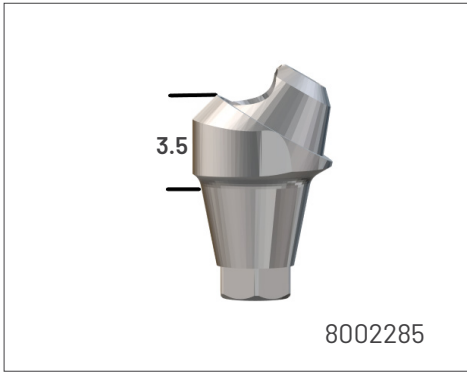

## Astra® Lilac 4.5 / 5.0mm (cont'd)

Item #	Product
8002281	4.5 / 5.0mm 17° Multi-Unit Abutment x 3.5mm
8002285	4.5 / 5.0mm 30° Multi-Unit Abutment x 3.5mm
8002286	4.5 / 5.0mm 30° Multi-Unit Abutment x 4.5mm
8002275	4.5 / 5.0mm Straight Multi-Unit Abutment x 1.5mm
8002276	4.5 / 5.0mm Straight Multi-Unit Abutment x 2.5mm
8002277	4.5 / 5.0mm Straight Multi-Unit Abutment x 3.5mm
8002278	4.5 / 5.0mm Straight Multi-Unit Abutment x 4.5mm
8002270	4.5 / 5.0mm Esthetic Abutment 15° Angle, Anterior
8002272	4.5 / 5.0mm Esthetic Abutment 15° Angle, Posterior
98002271	4.5 / 5.0mm Esthetic Abutment Straight, Anterior
8002273	4.5 / 5.0mm Esthetic Abutment Straight, Posterior
8002210	4.5 / 5.0mm Engaging Plastic UCLA
8002215	4.5 / 5.0mm Non-Engaging Plastic UCLA
9002265	4.5 / 5.0mm ASC Astra®-compatible Lilac Titanium Blank
9002267	4.5 / 5.0mm Astra®-compatible Lilac Titanium Blank

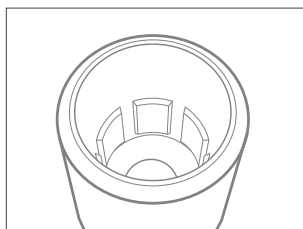

Compatible with  
Astra® Tech EV

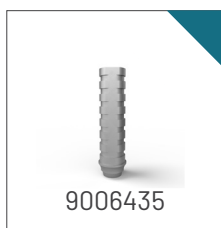

Astra® Tech EV 3.0mm	
Item #	Product
9006445	3.0mm Preat Choice Titanium Scan Body
9006400	3.0mm Analog
9006400-10	3.0mm Analog (10-Pack)
9006400-25	3.0mm Analog (25-Pack)
9006401	3.0mm Open-Tray Transfer
9006404	3.0mm Closed-Tray Transfer
9006452	3.0mm Closed-Tray Pin
9006403	3.0mm Digital Analog
9006403-10	3.0mm Digital Analog (10-Pack)
9006421	3.0mm x 2mm Healing Abutment (Wide)
9006422	3.0mm x 2mm Healing Abutment (Wide)
9006423	3.0mm x 4mm Healing Abutment
9006424	3.0mm x 4mm Healing Abutment (Wide)
9006430	3.0mm Engaging Verification Cylinder
9006430-10	3.0mm Engaging Verification Cylinder (10-Pack)
9006435	3.0mm Non-Engaging Verification Cylinder
9006435-10	3.0mm Non-Engaging Verification Cylinder (10-Pack)
9006490	ASC 3.0mm x 9mm Engaging Ti Base
9006495	ASC 3.0mm x 9mm Non-Engaging Ti Base

Astra® Tech EV 3.0mm Compatible

# IMPLANT PROSTHETICS

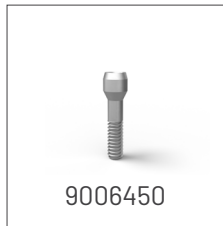
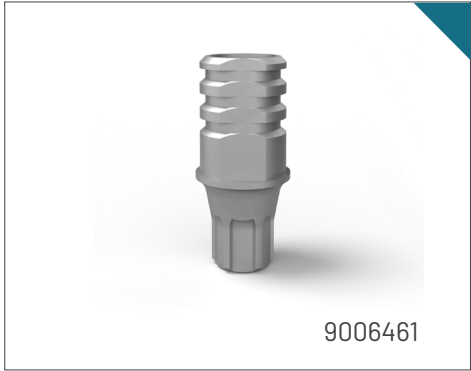

## Astra® Tech EV 3.0mm (cont'd)

Item #	Product
9006453	ASC 3.0mm Titanium Screw
9006459	3.0mm Non-Engaging Ti Base x 4.5mm
9006461	3.0mm Engaging Ti Base x 4.5mm
9006462	3.0mm Engaging Ti Base x 6mm
9006450	3.0mm Titanium Screw
9006450-10	3.0mm Titanium Screw (10-Pack)
9006451	3.0mm Guide Pin
9006465	3.0mm ASC Astra® EV-compatible Titanium Blank
9006467	3.0mm Astra® EV-compatible Titanium Blank

Astra® Tech EV 3.0mm Compatible



Astra® Tech EV 3.6mm	
Item #	Product
9006545	3.6mm Preat Choice Titanium Scan Body
9006500	3.6mm Analog
9006500-10	3.6mm Analog (10-Pack)
9006500-25	3.6mm Analog (25-Pack)
9006501	3.6mm Open-Tray Transfer
9006504	3.6mm Closed-Tray Transfer
9006552	3.6mm Closed-Tray Pin
9006503	3.6mm Digital Analog
9006503-10	3.6mm Digital Analog (10-Pack)
9006521	3.6mm X 2mm Healing Abutment
9006522	3.6mm X 2mm Healing Abutment (Wide)
9006523	3.6mm X 4mm Healing Abutment
9006524	3.6mm X 4mm Healing Abutment (Wide)
9006530	3.6mm Engaging Verification Cylinder
9006530-10	3.6mm Engaging Verification Cylinder (10-Pack)
9006535	3.6mm Non-Engaging Verification Cylinder
9006535-10	3.6mm Non-Engaging Verification Cylinder (10-Pack)
9006590	ASC 3.6mm x 9mm Engaging Ti Base
9006595	ASC 3.6mm x 9mm Non-Engaging Ti Base

# IMPLANT PROSTHETICS

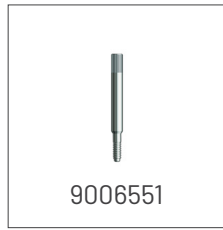

## Astra® Tech EV 3.6mm (cont'd)

Item #	Product
9006553	ASC 3.6mm Titanium Screw
9006559	3.6 X 4.5mm Non-Engaging Ti Base
9006561	3.6mm x 4.5mm Engaging Ti Base
9006562	3.6mm x 6mm Engaging Ti Base
9006550	3.6mm Titanium Screw
9006550-10	3.6mm Titanium Screw (10-Pack)
9006551	3.6mm Guide Pin
9006565	3.6mm ASC Astra® EV-compatible Titanium Blank
9006567	3.6mm Astra® EV-compatible Titanium Blank

Astra® Tech EV 3.6mm Compatible



## Astra® Tech EV 4.2mm

Item #	Product
9006645	4.2mm Preat Choice Titanium Scan Body
9006600	4.2mm Analog
9006600-10	4.2mm Analog (10-Pack)
9006600-25	4.2mm Analog (25-Pack)
9006601	4.2mm Open-Tray Transfer
9006604	4.2mm Closed-Tray Transfer
9006652	4.2mm Closed-Tray Pin
9006603	4.2mm Digital Analog
9006603-10	4.2mm Digital Analog (10-Pack)
9006621	4.2mm x 2mm Healing Abutment
9006622	4.2mm x 2mm Healing Abutment (Wide)
9006623	4.2mm x 4mm Healing Abutment
9006624	4.2mm x 4mm Healing Abutment (Wide)
9006630	4.2mm Engaging Verification Cylinder
9006630-10	4.2mm Engaging Verification Cylinder (10-Pack)
9006635	4.2mm Non-Engaging Verification Cylinder
9006635-10	4.2mm Non-Engaging Verification Cylinder (10 Pack)
9006690	4.2mm x 9mm ASC Engaging Ti Base
9006695	4.2mm x 9mm ASC Non-Engaging Ti Base

# IMPLANT PROSTHETICS

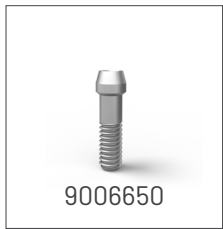

## Astra® Tech EV 4.2mm (cont'd)

Item #	Product
9006653	ASC 4.2mm Titanium Screw
9006659	4.2mm x 4.5mm Non-Engaging Ti Base
9006661	4.2mm x 4.5mm Engaging Ti Base
9006662	4.2mm x 6mm Engaging Ti Base
9006650	4.2mm Titanium Screw
9006650-10	4.2mm Titanium Screw (10-Pack)
9006651	4.2mm Guide Pin
9006665	4.2mm ASC Astra® EV-compatible Titanium Blank
9006667	4.2mm Astra® EV-compatible Titanium Blank

Astra® Tech EV 4.2mm Compatible



## Astra® Tech EV 4.8mm

Item #	Product
9006745	4.8mm Preat Choice Titanium Scan Body
9006700	4.8mm Analog
9006700-10	4.8mm Analog (10-Pack)
9006700-25	4.8mm Analog (25-Pack)
9006701	4.8mm Open-Tray Transfer
9006704	4.8mm Closed-Tray Transfer
9006752	4.8mm Closed-Tray Pin
9006703	4.8mm Digital Analog
9006703-10	4.8mm Digital Analog (10-Pack)
9006721	4.8mm X 2mm Healing Abutment
9006722	4.8mm X 2mm Healing Abutment (Wide)
9006723	4.8mm X 4mm Healing Abutment
9006724	4.8mm X 4mm Healing Abutment (Wide)
9006730	4.8mm Engaging Verification Cylinder
9006730-10	4.8mm Engaging Verification Cylinder (10-Pack)
9006735	4.8mm Non-Engaging Verification Cylinder
9006735-10	4.8mm Non-Engaging Verification Cylinder (10-Pack)

# IMPLANT PROSTHETICS



9006759



9006761



9006762



9006753



9006795



9006851



9006765

## Astra® Tech EV 4.8mm (cont'd)

Item #	Product
9006790	ASC 4.8mm x 9mm Engaging Ti Base
9006795	ASC 4.8mm x 9mm Non-Engaging Ti Base
9006753	ASC 4.8mm/5.4mm Titanium Screw
9006759	4.8mm x 4.5mm Non-Engaging Ti Base
9006761	4.8mm x 4.5mm Engaging Ti Base
9006762	4.8mm x 6mm Engaging Ti Base
9006750	4.8mm / 5.4mm Titanium Screw
9006750-10	4.8mm / 5.4mm Titanium Screw (10-Pack)
9006751	4.8mm / 5.4mm Guide Pin
9006765	4.8mm ASC Astra® EV-compatible Titanium Blank
9006767	4.8mm Astra® EV-compatible Titanium Blank

Astra® Tech EV 4.8mm Compatible



## Astra® Tech EV 5.4mm

Item #	Product
9006845	5.4mm Preat Choice Titanium Scan Body
9006800	5.4mm Analog
9006800-10	5.4mm Analog (10-Pack)
9006800-25	5.4mm Analog (25-Pack)
9006801	5.4mm Open-Tray Transfer
9006804	5.4mm Closed-Tray Transfer
9006852	5.4mm Closed-Tray Pin
9006803	5.4mm Digital Analog
9006803-10	5.4mm Digital Analog (10-Pack)
9006821	5.4mm X 2mm Healing Abutment
9006822	5.4mm X 2mm Healing Abutment (Wide)
9006823	5.4mm X 4mm Healing Abutment
9006824	5.4mm X 4mm Healing Abutment (Wide)
9006830	5.4mm Engaging Verification Cylinder
9006830-10	5.4mm Engaging Verification Cylinder (10-Pack)
8006850-10	5.4 Titanium Screw (10-Pack)
9006835	5.4mm Non-Engaging Verification Cylinder
9006835-10	5.4mm Non-Engaging Verification Cylinder (10-Pack)

# IMPLANT PROSTHETICS

Astra® Tech EV 5.4mm Compatible



## Astra® Tech EV 5.4mm (cont'd)

Item #	Product
9006890	ASC 5.4mm x 9mm Engaging Ti Base
9006895	ASC 5.4mm x 9mm Non-Engaging Ti Base
9006753	ASC 4.8mm/5.4mm Titanium Screw
9006859	5.4mm x 4.5mm Non-Engaging Ti Base
9006861	5.4mm x 4.5mm Engaging Ti Base
9006862	5.4mm x 6mm Engaging Ti Base
9006865	5.4mm ASC Astra® EV-compatible Titanium Blank
9006867	5.4mm Astra® EV-compatible Titanium Blank

**Screws and Guide Pins - [See page 90](#)**

### BIO-LOK Implant Systems

BIO-LOK External Hex	<i>Please see Nobel Branemark RP</i>
----------------------	--------------------------------------

### Blue Sky Bio Implant Systems

Blue Sky Bio Internal Hex 3.5mm Green	<i>Please see Zimmer TSV 3.5mm</i>
Blue Sky Bio Internal Hex 4.5mm Purple	<i>Please see Zimmer TSV 4.5mm</i>
Blue Sky Bio Tri-Lobe NP	<i>Please see Nobel Tri-Lobe NP</i>
Blue Sky Bio Tri-Lobe RP	<i>Please see Nobel Tri-Lobe RP</i>
Blue Sky Bio Tri-Lobe WP	<i>Please see Nobel Tri-Lobe WP</i>
Blue Sky Bio Tri-Lobe 6.0	<i>Please see Nobel Tri-Lobe 6.0</i>
Blue Sky Bio MAX	<i>Please see NobelActive™ / Conical NP</i>
Blue Sky Bio Three	<i>Please see Astra 3.0mm</i>
Blue Sky Bio CONUS 12 3.5 / 4.0	<i>Please see Astra Aqua 3.5 / 4.0mm</i>
Blue Sky Bio CONUS 12 4.5 / 5.0	<i>Please see Astra Lilac 4.5 / 5.0mm</i>
Blue Sky Bio One Stage RN (4.1mm)	<i>Please see Straumann Tissue Level RN</i>

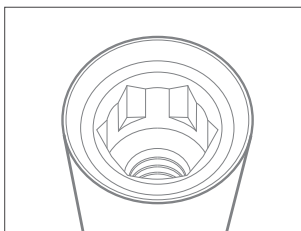

Compatible with  
**BioHorizons®**



## BioHorizons® 3.0mm

Item #	Product
9005245	3.0mm Preat Choice Titanium Scan Body <i>(for Preat Custom Solutions)</i>
9005200	3.0mm Analog
9005200-10	3.0mm Analog (10-Pack)
9005200-25	3.0mm Analog (25-Pack)
9005203	3.0mm Digital Analog
9005253	ASC 3.0mm Titanium Screw
9005265	3.0mm ASC BioHorizons®-compatible Titanium Blank
9005267	3.0mm BioHorizons®-compatible Titanium Blank

## BioHorizons® 3.5mm

Item #	Product
9005445	3.5mm Preat Choice Titanium Scan Body <i>(for Preat Custom Solutions)</i>
9005400	3.5mm Analog
9005400-10	3.5mm Analog (10-Pack)
9005400-25	3.5mm Analog (25-Pack)
9005403	3.5mm Digital Analog
9005453	ASC 3.5mm/4.5mm Titanium Screw
9005465	3.5mm ASC BioHorizons®-compatible Titanium Blank
9005467	3.5mm BioHorizons®-compatible Titanium Blank

**See Zimmer TSV for additional options**

## BioHorizons® 4.5mm

Item #	Product
9005545	4.5mm Preat Choice Titanium Scan Body <i>(for Preat Custom Solutions)</i>
9005500	4.5mm Analog
9005500-10	4.5mm Analog (10-Pack)
9005500-25	4.5mm Analog (25-Pack)
9005503	4.5mm Digital Analog
9005565	4.5mm ASC BioHorizons®-compatible Titanium Blank
9005567	4.5mm BioHorizons®-compatible Titanium Blank

**See Zimmer TSV for additional options**

BioHorizons® 3.0 Implant Compatible

## Compatible with Brånemark®

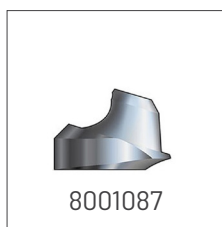
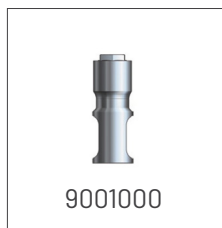

## Brånemark® RP 3.75 / 4.1mm

Item #	Product
8001041	Titanium Scan Body (for use with Ti Bases)
9001000	Analog
9001000-10	Analog (10-Pack)
9001000-25	Analog (25-Pack)
8001035	Non-Engaging Verification Cylinder
8001035-10	Non-Engaging Verification Cylinder (10-Pack)
8001030	Engaging Verification Cylinder
8001030-10	Engaging Verification Cylinder (10-Pack)
8001059	Non-Engaging Ti Base x 4.5mm
8001061	Engaging Ti Base x 4.5mm
8001062	Engaging Ti Base x 6mm
9001050	Titanium Screw
9001050-10	Titanium Screw (10-Pack)
8001051	Guide Pin 20mm
8001089	Multi-Unit Titanium Screw
8001085	17° Multi-Unit Abutment x 2mm
8001086	17° Multi-Unit Abutment x 3mm
8001087	17° Multi-Unit Abutment x 4mm
8001091	30° Multi-Unit Abutment x 4mm
8001092	30° Multi-Unit Abutment x 5mm

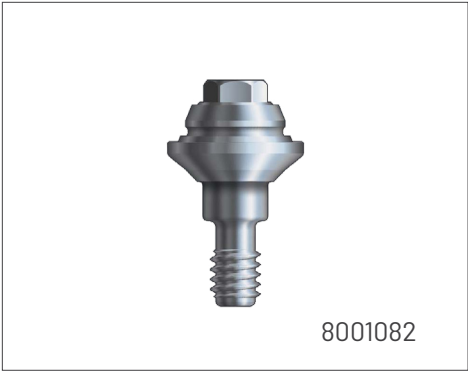

## Brånemark® RP 3.75 / 4.1mm (cont'd)

Item #	Product
8001081	Straight Multi-Unit Abutment x 1mm
8001082	Straight Multi-Unit Abutment x 2mm
8001083	Straight Multi-Unit Abutment x 3mm
8001010	Engaging Plastic UCLA
8001015	Non-Engaging Plastic UCLA

Brånemark® RP 3.75 / 4.1mm Compatible

## Compatible with CAMLOG® Screw-Line

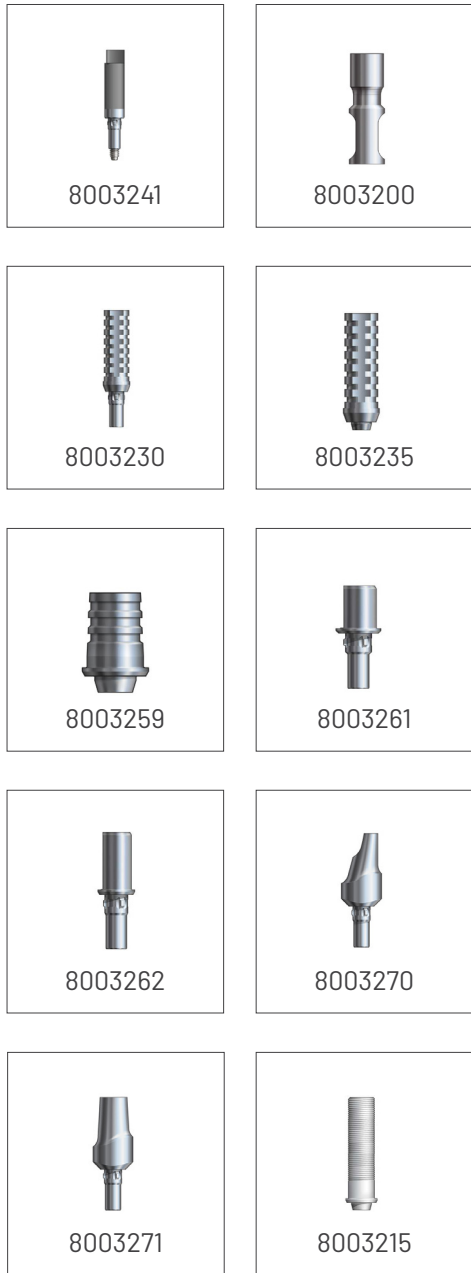

## CAMLOG Screw-Line 3.3mm

Item #	Product
8003241	3.3mm Titanium Scan Body <i>(for use with Ti Bases)</i>
8003200	3.3mm Analog
8003200-10	3.3mm Analog (10-Pack)
8003230	3.3mm Engaging Verification Cylinder
8003230-10	3.3mm Engaging Verification Cylinder (10-Pack)
8003235	3.3mm Non-Engaging Verification Cylinder
8003235-10	3.3mm Non-Engaging Verification Cylinder (10-Pack)
8003259	3.3mm x 4.5mm Non-Engaging Ti Base
8003261	3.3mm Engaging Ti Base x 4.5mm
8003262	3.3mm x 6mm Engaging Ti Base
8003250	<u>3.3mm / 3.8mm / 4.3mm</u> Titanium Screw
8003250-10	<u>3.3mm / 3.8mm / 4.3mm</u> Titanium Screw (10-Pack)
8003251	<u>3.3mm / 3.8mm / 4.3mm</u> Guide Pin 20mm
8003270	3.3mm Esthetic Abutment 15° Angle, Anterior
8003271	3.3mm Esthetic Abutment Straight, Anterior
8003215	3.3mm Non-Engaging Plastic UCLA

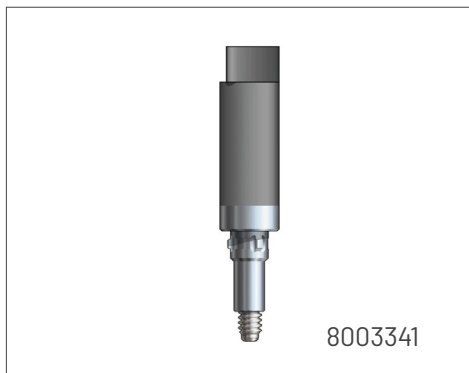

## CAMLOG Screw-Line 3.8mm

Item #	Product
8003341	3.8mm Titanium Scan Body <i>(for use with Ti Bases)</i>
8003300	3.8mm Analog
8003300-10	3.8mm Analog (10-Pack)
8003335	3.8mm Non-Engaging Verification Cylinder
8003335-10	3.8mm Non-Engaging Verification Cylinder (10-Pack)
8003330	3.8mm Engaging Verification Cylinder
8003330-10	3.8mm Engaging Verification Cylinder (10-Pack)
8003359	3.8mm x 4.5mm Non-Engaging Ti Base
8003361	3.8mm x 4.5mm Engaging Ti Base
8003362	3.8mm x 6mm Engaging Ti Base
	Screws and Guide Pins - <a href="#">See page 96</a>
8003489	3.8mm / 4.3mm Multi-Unit Titanium Screw
8003375	3.8mm x 1mm Straight Multi-Unit Abutment
8003376	3.8mm x 2mm Straight Multi-Unit Abutment
8003377	3.8mm x 3mm Straight Multi-Unit Abutment
8003380	3.8mm x 2mm 17° Multi-Unit Abutment

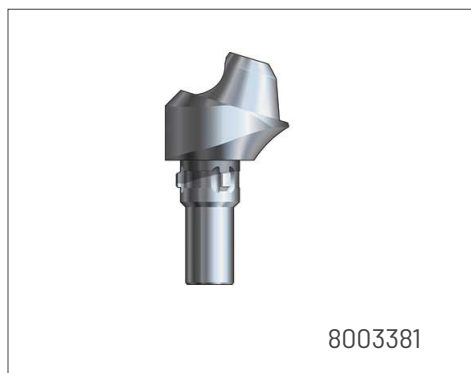

## CAMLOG Screw-Line 3.8mm (cont'd)

Item #	Product
8003381	3.8mm x 3mm 17° Multi-Unit Abutment
8003385	3.8mm x 3mm 30° Multi-Unit Abutment
8003387	3.8mm x 5mm 30° Multi-Unit Abutment
8003370	3.8mm Esthetic Abutment 15° Angle, Anterior
8003371	3.8mm Esthetic Abutment Straight, Anterior
8003315	3.8mm Non-Engaging Plastic UCLA

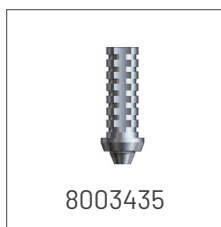
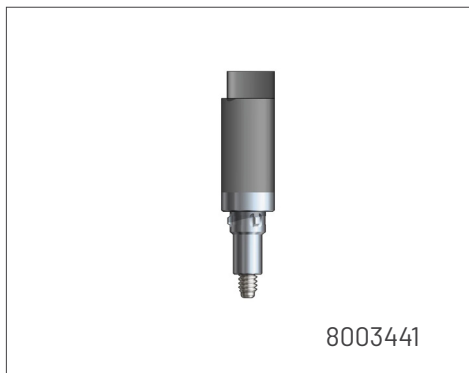

## CAMLOG Screw-Line 4.3mm

Item #	Product
8003441	4.3mm Titanium Scan Body <i>(for use with Ti Bases)</i>
8003400	4.3mm Analog
8003400-10	4.3mm Analog (10-Pack)
8003430	4.3mm Engaging Verification Cylinder
8003430-10	4.3mm Engaging Verification Cylinder (10-Pack)
8003435	4.3mm Non-Engaging Verification Cylinder
8003435-10	4.3mm Non-Engaging Verification Cylinder (10-Pack)
8003459	4.3mm x 4.5mm Non-Engaging Ti Base
8003461	4.3mm x 4.5mm Engaging Ti Base
8003462	4.3mm x 6mm Engaging Ti Base
	Screws and Guide Pins - <a href="#">See page 96</a>
8003480	4.3mm 17° Multi-Unit Abutment x 2mm
8003481	4.3mm 17° Multi-Unit Abutment x 3mm
8003483	4.3mm 17° Multi-Unit Abutment x 5mm
8003485	4.3mm 30° Multi-Unit Abutment x 3mm
8003487	4.3mm 30° Multi-Unit Abutment x 5mm

# IMPLANT PROSTHETICS



8003476



8003470



8003471

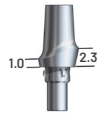

8003473



8003415

CAMLOG Screw-Line 4.3mm Compatible

## CAMLOG Screw-Line 4.3mm (cont'd)

Item #	Product
8003475	4.3mm Straight Multi-Unit Abutment x 1mm
8003476	4.3mm Straight Multi-Unit Abutment x 2mm
8003477	4.3mm Straight Multi-Unit Abutment x 3mm
8003479	4.3mm Straight Multi-Unit Abutment x 5mm
8003470	4.3mm Esthetic Abutment 15° Angle, Anterior
8003472	4.3mm Esthetic Abutment 15° Angle, Posterior
8003471	4.3mm Esthetic Abutment Straight, Anterior
8003473	4.3mm Esthetic Abutment Straight, Posterior
8003415	4.3mm Non-Engaging Plastic UCLA

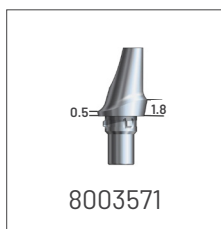
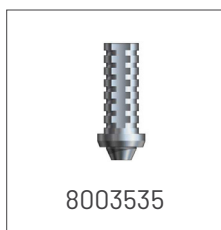
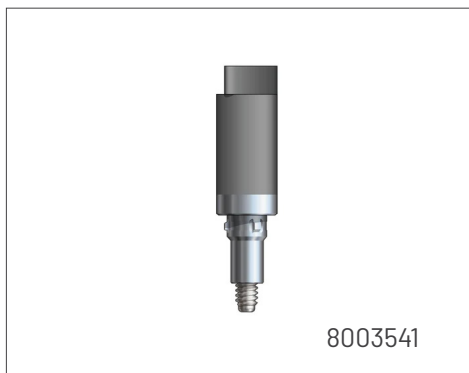

## CAMLOG Screw-Line 5.0mm

Item #	Product
8003541	5.0mm Titanium Scan Body <i>(for use with Ti Bases)</i>
8003500	5.0mm Analog
8003500-10	5.0mm Analog (10-Pack)
8003530	5.0mm Engaging Verification Cylinder
8003530-10	5.0mm Engaging Verification Cylinder (10-Pack)
8003535	5.0mm Non-Engaging Verification Cylinder
8003535-10	5.0mm Non-Engaging Verification Cylinder (10-Pack)
8003559	5.0mm Non-Engaging Ti Base x 4.5mm
8003561	5.0mm Engaging Ti Base x 4.5mm
8003562	5.0mm Engaging Ti Base x 6mm
8003555	<u>5.0mm/6.0mm</u> Titanium Screw
8003555-10	<u>5.0mm/6.0mm</u> Titanium Screw (10-Pack)
8003551	<u>5.0mm/6.0mm</u> Guide Pin 20mm
8003575	5.0mm Straight Multi-Unit Abutment x 1mm
8003576	5.0mm Straight Multi-Unit Abutment x 2mm
8003577	5.0mm Straight Multi-Unit Abutment x 3mm
8003571	5.0mm Esthetic Abutment 15° Angle, Posterior
8003573	5.0mm Esthetic Abutment Straight, Posterior
8003515	5.0mm Non-Engaging Plastic UCLA

# IMPLANT PROSTHETICS

CAMLOG Screw-Line 6.0mm Compatible

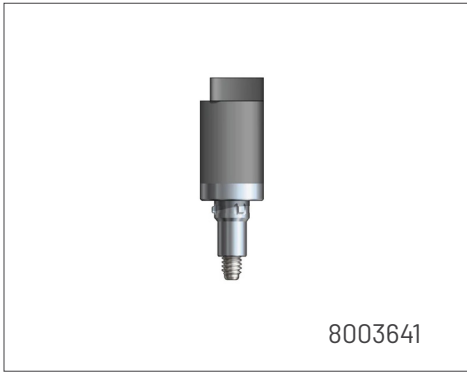

## CAMLOG Screw-Line 6.0mm

Item #	Product
8003641	6.0mm Titanium Scan Body (for use with Ti Bases)
8003600	6.0mm Analog
8003600-10	6.0mm Analog (10-Pack)
8003635	6.0mm Non-Engaging Verification Cylinder
8003630	6.0mm Engaging Verification Cylinder
8003659	6.0mm Non-Engaging Ti Base x 4.5mm
8003661	6.0mm Engaging Ti Base x 4.5mm
8003662	6.0mm Engaging Ti Base x 6mm
	Screws and Guide Pins - <a href="#">See page 101</a>
8003615	6.0mm Non-Engaging Plastic UCLA

## Glidewell Laboratories Implant Systems

Glidewell Inclusive 3.5mm	<i>Please see Zimmer TSV 3.5mm</i>
Glidewell Inclusive 3.5mm	<i>Please see Zimmer TSV 4.5mm</i>
Glidewell Hahn Tapered 3.0	<i>Please see Nobel Active / Conical 3.0</i>
Glidewell Hahn Tapered 3.5 / 4.3	<i>Please see Nobel Active / Conical NP</i>
Glidewell Hahn Tapered 5.0	<i>Please see Nobel Active / Conical RP</i>
Glidewell Hahn Tapered 7.0	<i>Please see Nobel Active / Conical WP</i>

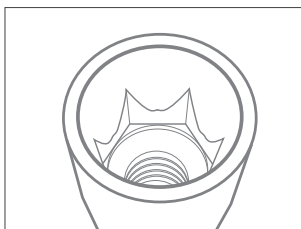

Compatible with  
Hiossen® ETIII



## Hiossen Mini 3.5mm

Item #	Product
8005021	HG Mini Healing Abutment 4 x 3mm
8005023	HG Mini Healing Abutment 4 x 5mm
8005004	HG Mini Closed Tray Impression Coping 3.8 x 9mm
9005045	HG Mini Preat Choice Titanium Scan Body
9005100	HG Mini Analog
9005100-10	HG Mini Analog (10-Pack)
9005100-25	HG Mini Analog (25-Pack)
9005103	HG Mini Digital Analog
9005103-10	HG Mini Digital Analog (10-Pack)
9005035	HG Mini Non-Engaging Verification Cylinder
9005035-10	HG Mini Non-Engaging Verification Cylinder (10-Pack)
9005030	HG Mini Engaging Verification Cylinder
9005030-10	HG Mini Engaging Verification Cylinder (10-Pack)
9005090	ASC HG Mini x 9mm Engaging Ti Base
9005095	ASC HG Mini x 9mm Non-Engaging Ti Base

# IMPLANT PROSTHETICS

Hiossen Mini 3.5mm Compatible

108

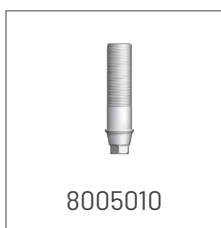
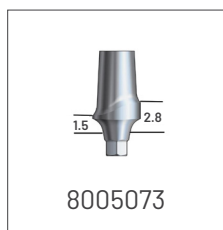
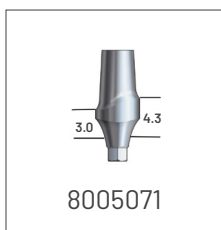
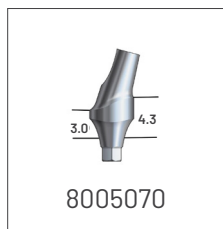
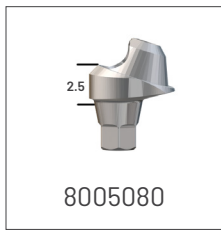

## Hiossen Mini 3.5mm (cont'd)

Item #	Product
9005053	ASC HG Mini Titanium Screw
9005061	HG Mini Engaging Ti Base x 4.5mm
9005062	HG Mini Engaging Ti Base x 6mm
9005050	HG Mini Titanium Screw
9005050-10	HG Mini Titanium Screw (10-Pack)
9005051	HG Mini Guide Pin
9005089	HG Mini Multi Unit Titanium Screw
8005080	HG Mini 17° Multi-Unit Abutment x 2.5mm
8005081	HG Mini 17° Multi-Unit Abutment x 3.5mm
8005085	HG Mini 30° Multi-Unit Abutment x 3.5mm
8005086	HG Mini 30° Multi-Unit Abutment x 4.5mm
8005075	HG Mini Straight Multi-Unit Abutment x 1.5mm
8005076	HG Mini Straight Multi-Unit Abutment x 2.5mm
8005077	HG Mini Straight Multi-Unit Abutment x 3.5mm
8005070	HG Mini Esthetic Abutment 15° Angle, Anterior
8005072	HG Mini Esthetic Abutment 15° Angle, Posterior
8005071	HG Mini Esthetic Abutment Straight, Anterior
8005073	HG Mini Esthetic Abutment Straight, Posterior
8005010	HG Mini Engaging Plastic UCLA
8005015	HG Mini Non-Engaging Plastic UCLA
9005065	ASC Hiossen® HG-compatible Mini Titanium Blank
9005067	Hiossen® HG-compatible Mini Titanium Blank

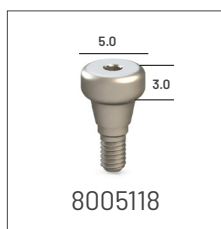

## Hiossen Regular 4.0 / 4.5 / 5.0mm

Item #	Product
8005118	HG Regular Healing Abutment 5 x 3mm
8005119	HG Regular Healing Abutment 5 x 5mm
8005121	HG Regular Healing Abutment 6 x 3mm
8005123	HG Regular Healing Abutment 6 x 5mm
8005104	HG Regular Closed Tray Impression Coping 4.5 x 9mm
9005145	HG Regular Preat Choice Titanium Scan Body
9005000	HG Regular Analog
9005000-10	HG Regular Analog (10-Pack)
9005003	HG Regular Digital Analog
9005003-10	HG Regular Digital Analog (10-Pack)
9005130	HG Regular Engaging Verification Cylinder
9005130-10	HG Regular Engaging Verification Cylinder (10-Pack)
9005135	HG Regular Non-Engaging Verification Cylinder
9005135-10	HG Regular Non-Engaging Verification Cylinder (10-Pack)
9005190	ASC HG Regular x 9mm Engaging Ti Base
9005195	ASC HG Regular x 9mm Non-Engaging Ti Base
9005153	ASC Hiossen® HG-compatible Regular Titanium Screw
9005159	HG Regular Non-Engaging Ti Base x 4.5mm
9005161	HG Regular Engaging Ti Base x 4.5mm
9005162	HG Regular Engaging Ti Base x 6mm

# Preat Angled Screw Channel Titanium Bases

## EXPANDED CUSTOMIZATION. SIMPLIFIED INVENTORY.

Designed with a 9 mm height, customizable to 7 mm or 5 mm for optimal fit

Blasted surface and retention grooves improve cement adhesion

Gold hue anodization for improved aesthetics

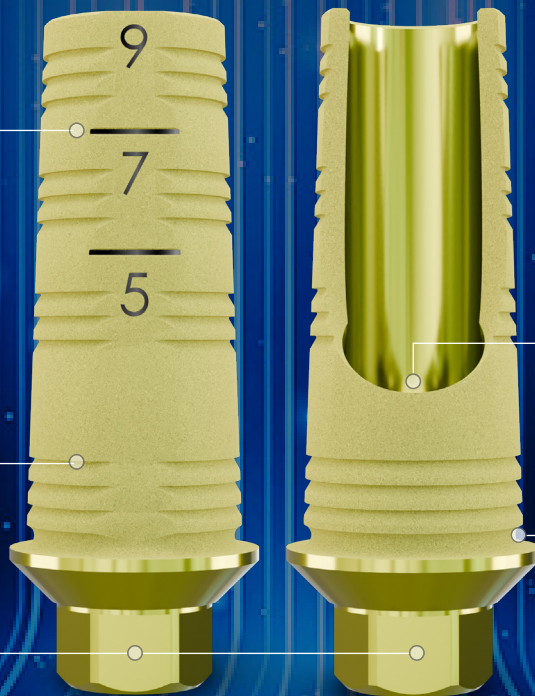

Variable screw channel provides 0-30° angulation for easy adjustment to optimize esthetics and accommodate challenging cases

Cement groove helps prevent cement overflow when adhering crown

With 29 interfaces, Preat's ASC Ti Bases provide broad compatibility with the leading implants on the market. Available in engaging and non-engaging implant-level and multi-unit options.



**SCAN OR** [CLICK HERE](#)  
to Explore the Collection

## Hiossen Regular 4.0 / 4.5 / 5.0mm (cont'd)

Item #	Product
9005150	HG Regular Titanium Screw
9005150-10	HG Regular Titanium Screw (10-Pack)
9005151	HG Regular Guide Pin
8005189	HG Regular Multi Unit Titanium Screw
8005180	HG Regular 17° Multi-Unit Abutment x 2.5mm
8005181	HG Regular 17° Multi-Unit Abutment x 3.5mm
8005185	HG Regular 30° Multi-Unit Abutment x 3.5mm
8005186	HG Regular 30° Multi-Unit Abutment x 4.5mm
8005175	HG Regular Straight Multi-Unit Abutment x 1.5mm
8005176	HG Regular Straight Multi-Unit Abutment x 2.5mm
8005177	HG Regular Straight Multi-Unit Abutment x 3.5mm
8005178	HG Regular Straight Multi-Unit Abutment x 4.5mm
8005170	HG Regular Esthetic Abutment 15° Angle, Anterior
8005172	HG Regular Esthetic Abutment 15° Angle, Posterior
8005171	HG Regular Esthetic Abutment Straight, Anterior
8005173	HG Regular Esthetic Abutment Straight, Posterior
8005115	HG Regular Non-Engaging Plastic UCLA
8005110	HG Regular Engaging Plastic UCLA
9005165	ASC Hiossen® HG-compatible Regular Titanium Blank
9005167	Hiossen® HG-compatible Regular Titanium Blank



9005159



9005150



9005151



8005181



8005175



8005170



8005171

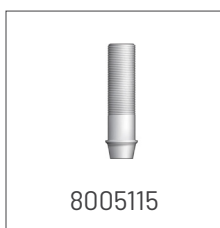

8005115



9005167

Hiossen Regular 4.0 / 4.5 / 5.0mm Compatible

Hiossen Implant System

### Hiossen Implant Systems

Hiossen Plus Wide 5.1mm

*Please see Nobel Branemark WP*

Hiossen Regular 4.1mm

*Please see Nobel Branemark RP*

Hiossen SS Regular 4.8mm

*Please see Straumann Tissue Level RN*

# IMPLANT PROSTHETICS

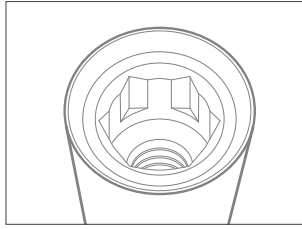

Compatible with Implant  
Direct Legacy™



112

## Implant Direct Legacy™ 3.0mm

Item #	Product
9005345	Preat Choice Titanium Scan Body <i>(for Preat Custom Solutions)</i>
9005300	Analog
9005300-10	Analog (10-Pack)
9005300-25	Analog (25-Pack)
9005303	Digital Analog
9005353	ASC 3.0mm Titanium Screw
9005365	3.0mm ASC Legacy™-compatible Titanium Blank
9005367	3.0mm Legacy™-compatible Titanium Blank

## Implant Direct Legacy™ 3.5mm

Item #	Product
9005645	Preat Choice Titanium Scan Body <i>(for Preat Custom Solutions)</i>
9005600	Analog
9005600-10	Analog (10-Pack)
9005600-25	Analog (25-Pack)
9005603	Digital Analog
9005653	ASC 3.5mm/4.5mm/5.7mm Titanium Screw
9005665	3.5mm ASC Legacy™-compatible Titanium Blank
9005667	3.5mm Legacy™-compatible Titanium Blank

See Zimmer TSV 3.5mm for additional options

Implant Direct Legacy Compatible

Implant Direct Legacy Compatible



9007545



9007500



9008500



9008545

## Implant Direct Legacy™ 4.5mm

Item #	Product
9007545	Preat Choice Titanium Scan Body <i>(for Preat Custom Solutions)</i>
9007500	Analog
9007500-10	Analog (10-Pack)
9007500-25	Analog (25-Pack)
9007503	Digital Analog
9007565	4.5mm ASC Legacy™-compatible Titanium Blank
9007567	4.5mm Legacy™-compatible Titanium Blank

## Implant Direct Legacy™ 5.7mm

Item #	Product
9008545	Preat Choice Titanium Scan Body <i>(for Preat Custom Solutions)</i>
9008500	Analog
9008500-10	Analog (10-Pack)
9008500-25	Analog (25-Pack)
9008503	Digital Analog
9008565	5.7mm ASC Legacy™-compatible Titanium Blank
9008567	5.7mm Legacy™-compatible Titanium Blank

**See Zimmer TSV for additional options**

## Implant Direct Implant Systems

Implant Direct Implant Systems

Implant Direct InterActive™ /Simply Iconic™ NP	<i>Please see NobelActive / Conical NP</i>
Implant Direct InterActive™ /Simply Iconic™ RP	<i>Please see NobelActive / Conical RP</i>
Implant Direct RePlant™ / RePlus™ / ReActive NP™	<i>Please see Nobel Tri-Lobe NP</i>
Implant Direct RePlant™ / RePlus™ / ReActive RP™	<i>Please see Nobel Tri-Lobe RP</i>
Implant Direct RePlant™ / RePlus™ / ReActive WP™	<i>Please see Nobel Tri-Lobe WP</i>
Implant Direct SwishPlant™ / SwishPlus™ (4.8mmD)	<i>Please see Straumann Tissue Level RN</i>

# IMPLANT PROSTHETICS

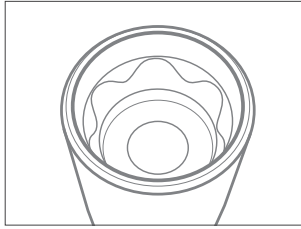

Compatible with  
Keystone® TiLobe®

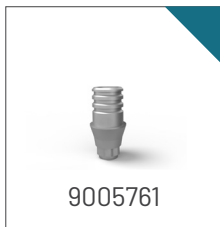

## Keystone TiLobe 3.5mm

Item #	Product
9005745	3.5mm Preat Choice Titanium Scan Body
9005700	3.5mm Analog
9005700-10	3.5mm Analog (10-Pack)
9005700-25	3.5mm Analog (25-Pack)
9005701	3.5mm Open-Tray Transfer
9005704	3.5mm Closed-Tray Transfer
9005752	3.5mm/4.1mm/5.0mm Closed-Tray Pin
9005703	3.5mm Digital Analog
9005703-10	3.5mm Digital Analog (10-Pack)
9005721	3.5mm X 2mm Healing Abutment
9005722	3.5mm X 2mm Healing Abutment (Wide)
9005723	3.5mm X 4mm Healing Abutment
9005724	3.5mm X 4mm Healing Abutment (Wide)
9005730	3.5mm Engaging Verification Cylinder
9005730-10	3.5mm Engaging Verification Cylinder (10-Pack)
9005735	3.5mm Non-Engaging Verification Cylinder
9005735-10	3.5mm Non-Engaging Verification Cylinder (10-Pack)
9005790	ASC 3.5mm x 9mm Engaging Ti Base
9005795	ASC 3.5mm x 9mm Non-Engaging Ti Base
9005753	ASC 3.5mm/4.1mm/5.0mm Titanium Screw
9005759	3.5mm x 4.5mm Non-Engaging Ti Base
9005761	3.5mm x 4.5mm Engaging Ti Base
9005762	3.5mm x 6mm Engaging Ti Base
9005750	3.5mm / 4.1mm / 5.0mm Titanium Screw
9005751	3.5mm / 4.1mm / 5.0mm Guide Pin
9005765	3.5mm ASC Keystone TiLobe®-compatible Titanium Blank
9005767	3.5mm Keystone TiLobe®-compatible Titanium Blank

Keystone TiLobe 3.5mm Compatible

Keystone TiLobe 4.1mm Compatible



## Keystone TiLobe 4.1mm

Item #	Product
9005845	4.1mm Preat Choice Titanium Scan Body
9005800	4.1mm Analog
9005800-10	4.1mm Analog (10-Pack)
9005800-25	4.1mm Analog (25-Pack)
9005801	4.1mm Open-Tray Transfer
9005803	4.1mm Digital Analog
9005803-10	4.1mm Digital Analog (10-Pack)
9005804	4.1mm Closed-Tray Transfer
9005821	4.1mm X 2mm Healing Abutment
9005822	4.1mm X 2mm Healing Abutment (Wide)
9005823	4.1mm X 4mm Healing Abutment
9005824	4.1mm X 4mm Healing Abutment (Wide)
9005830	4.1mm Engaging Verification Cylinder
9005830-10	4.1mm Engaging Verification Cylinder (10-Pack)
9005835	4.1mm Non-Engaging Verification Cylinder
9005835-10	4.1mm Non-Engaging Verification Cylinder (10-Pack)
9005890	ASC 4.1mm x 9mm Engaging Ti Base
9005895	ASC 4.1mm x 9mm Non-Engaging Ti Base
9005859	4.1mm x 4.5mm Non-Engaging Ti Base
9005861	4.1mm x 4.5mm Engaging Ti Base
9005862	4.1mm x 6mm Engaging Ti Base
9005865	4.1mm ASC Keystone TiLobe®-compatible Titanium Blank
9005867	4.1mm Keystone TiLobe®-compatible Titanium Blank

# IMPLANT PROSTHETICS



## Keystone TiLobe 5.0mm

Item #	Product
9005945	5.0mm Preat Choice Titanium Scan Body
9005900	5.0mm Analog
9005900-10	5.0mm Analog (10-Pack)
9005900-25	5.0mm Analog (25-Pack)
9005901	5.0mm Open-Tray Transfer
9005903	5.0mm Digital Analog
9005903-10	5.0mm Digital Analog (10-Pack)
9005904	5.0mm Closed-Tray Transfer
9005921	5.0mm X 2mm Healing Abutment
9005922	5.0mm X 2mm Healing Abutment (Wide)
9005923	5.0mm X 4mm Healing Abutment
9005924	5.0mm X 4mm Healing Abutment (Wide)
9005930	5.0mm Engaging Verification Cylinder
9005930-10	5.0mm Engaging Verification Cylinder (10-Pack)
9005935	5.0mm Non-Engaging Verification Cylinder
9005935-10	5.0mm Non-Engaging Verification Cylinder (10-Pack)
9005990	ASC 5.0mm x 9mm Engaging Ti Base
9005995	ASC 5.0mm x 9mm Non-Engaging Ti Base
9005959	5.0mm Non-Engaging Ti Base x 4.5mm
9005961	5.0mm Engaging Ti Base x 4.5mm
9005962	5.0mm Engaging Ti Base x 6mm
9005965	5.0mm ASC Keystone TiLobe®-compatible Titanium Blank
9005967	5.0mm Keystone TiLobe®-compatible Titanium Blank

Keystone TiLobe 5.0mm Compatible

Hi-Tec® Implant Systems

Hi-Tec® Implant Systems	
Hi-Tec Tapered 3.5mm	<i>Please see Zimmer TSV 3.5mm</i>
Hi-Tec Tapered 4.5mm	<i>Please see Zimmer TSV 4.5mm</i>
Hi-Tec Vision 3.5mm	<i>Please see Nobel Tri-Lobe NP</i>
Hi-Tec Vision 4.3mm	<i>Please see Nobel Tri-Lobe RP</i>
Hi-Tec Vision 5.0mm	<i>Please see Nobel Tri-Lobe WP</i>
Hi-Tec Logic 3.5mm	<i>Please see Nobel Active / Conical NP</i>
Hi-Tec Logic 4.3 / 5.0mm	<i>Please see Nobel Active / Conical RP</i>
Hi-Tec Tapered Tite Fit 4.8mm	<i>Please see Straumann Tissue Level RN</i>
Hi-Tec Implex / Summitt 4.1mm	<i>Please see Nobel Branemark RP</i>

Imtec® Implant Systems

Imtec® Implant Systems	
Imtec 3.40 / 3.75 / 4.0 External Hex	<i>Please see Nobel Branemark RP</i>

IMZ Implant Systems

IMZ Implant Systems	
IMZ 3.3 / 4.0 External Hex	<i>Please see Nobel Branemark RP</i>
Innova Endopore 4.1mm	<i>Please see Nobel Branemark RP</i>

Lifecore Implant Systems

Lifecore Implant Systems	
Lifecore Stage One™ 3.3 / 4.1 / 4.8mm (RDS)	<i>Please see Straumann Tissue Level RN</i>

# YOUR KEY TO RESTORATIVE CHOICE

The Preat Choice Library was built on the concept of giving you restorative choice from a single scan body. Now it's even easier to access our eighteen different options for fixture-level cases and nine restorative solutions for multi-unit level cases with the new titanium scan body. Whether you are scanning intraorally or in the laboratory, the scan body fits within your workflow and **allows you to design the best possible restoration for the case.**

## TITANIUM SCAN BODY

### MATTE FINISH

Easy scanning with no reflection

### TITANIUM

Radiopaque to verify fit intraorally

### LASER ETCHED

Clearly identify the system and size plus easily match with the product description in the CAD software



DESIGN RESTORATIONS WITH

3shape  exocad

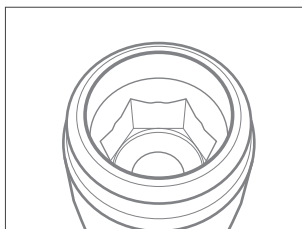

Compatible with  
MegaGen® AnyRidge®

## MegaGen AnyRidge

Item #	Product
8004418	Healing Abutment 5 x 3mm
8004419	Healing Abutment 5 x 5mm
8004421	Healing Abutment 6 x 3mm
8004423	Healing Abutment 6 x 5mm
8004405	Closed Tray Impression Coping 4.5 x 12mm
8004404	Closed Tray Impression Coping 4.5 x 9mm
9004445	Preat Choice Titanium Scan Body
9004400	Analog
9004400-10	Analog (10-Pack)
9004400-25	Analog (25-Pack)
9004403	Digital Analog
9004403-10	Digital Analog (10-Pack)
9004435	Non-Engaging Verification Cylinder
9004435-10	Non-Engaging Verification Cylinder (10-Pack)
9004430	Engaging Verification Cylinder
9004430-10	Engaging Verification Cylinder (10-Pack)
9004490	ASC x 9mm Non-Engaging Ti Base
9004495	ASC x 9mm Engaging Ti Base
9004453	ASC MegaGen AnyRidge®-compatible Titanium Screw
9004459	Non-Engaging Ti Base x 4.5mm

MegaGen AnyRidge Compatible

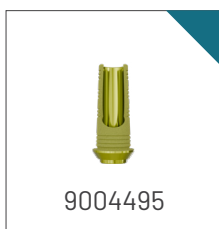
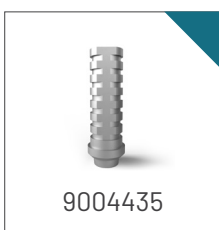
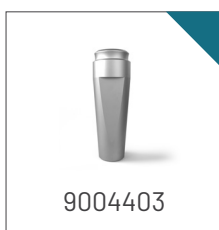

# IMPLANT PROSTHETICS



9004461



9004450



9004451

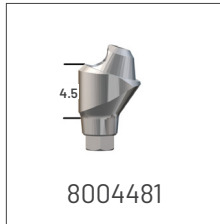

8004481



8004485



8004486

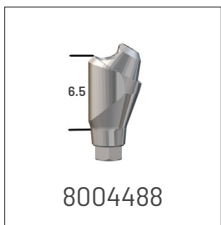

8004488



8004475

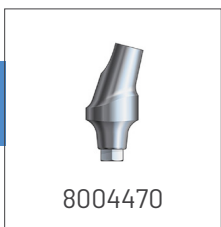

8004470



8004472

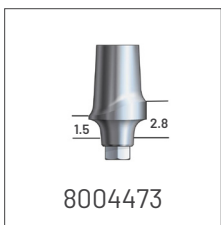

8004473



8004410

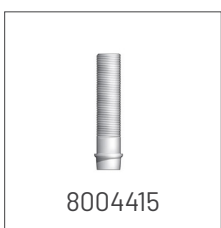

8004415



9004465

## MegaGen AnyRidge (cont'd)

Item #	Product
9004461	Engaging Ti Base x 4.5mm
9004462	Engaging Ti Base x 6mm
9004450	Titanium Screw
9004450-10	Titanium Screw (10-Pack)
9004451	Guide Pin
8004489	Multi Unit Titanium Screw
8004480	17° Multi-Unit Abutment x 3.5mm
8004481	17° Multi-Unit Abutment x 4.5mm
8004482	17° Multi-Unit Abutment x 5.5mm
8004485	30° Multi-Unit Abutment x 3.5mm
8004486	30° Multi-Unit Abutment x 4.5mm
8004487	30° Multi-Unit Abutment x 5.5mm
8004488	30° Multi-Unit Abutment x 6.5mm
8004475	Straight Multi-Unit Abutment x 2mm
8004476	Straight Multi-Unit Abutment x 3mm
8004477	Straight Multi-Unit Abutment x 4mm
8004478	Straight Multi-Unit Abutment x 5mm
8004470	Esthetic Abutment 15° Angle, Anterior
8004472	Esthetic Abutment 15° Angle, Posterior
8004471	Esthetic Abutment Straight, Anterior
8004473	Esthetic Abutment Straight, Posterior
8004410	Engaging Plastic UCLA
8004415	Non-Engaging Plastic UCLA
9004465	ASC MegaGen AnyRidge®-compatible Titanium Blank
9004467	MegaGen AnyRidge®-compatible Titanium Blank

MegaGen AnyRidge Compatible

MegaGen Implant Systems

MegaGen Implant Systems	
MegaGen Anyone RP (Internal	<i>Please see Hiossen Regular</i>
MegaGen ExFeel External Hex	<i>Please see Nobel Branemark RP</i>
MegaGen ExFeel 4.8	<i>Please see Straumann Tissue Level RN</i>

MIS Implant Systems

MIS Implant Systems	
MIS C4 3.75 / 4.20mm	<i>Please see Zimmer TSV 3.5mm</i>
MIS SEVEN 3.75 / 4.20mm	<i>Please see Zimmer TSV 3.5mm</i>
MIS Lance External Hex 4.1mm	<i>Please see Nobel Branemark RP</i>
MIS Mistral Internal Morse Taper One Stage RN	<i>Please see Straumann Tissue Level RN</i>

# IMPLANT PROSTHETICS

PREAT Multi-Unit Components are compatible with industry-standard Multi-Unit prosthetic connection and abutments.

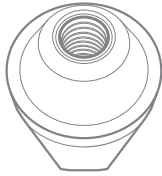

## Multi-Unit

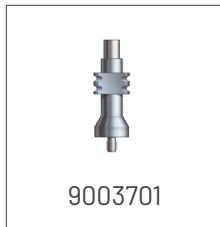

## Multi-Unit Components

Item #	Product
8003706	Multi-Unit Temporary Healing Cap
9003701	Multi-Unit Open-Tray Impression Coping
9003702	Multi-Unit Closed-Tray Impression Coping
9003743	Multi-Unit Preat Choice Titanium Scan Body w/.048 Screw
9003742	Multi-Unit Preat Choice Titanium Scan Body w/SRA Screw
9003741	Multi-Unit Preat Choice Titanium Scan Body w/.050 Screw
9003740	Multi-Unit Preat Choice Titanium Scan Body w/Unigrip Screw
9003700	Multi-Unit Abutment Analog
9003700-10	Multi-Unit Abutment Analog (10-Pack)
9003700-25	Multi-Unit Abutment Analog (25-Pack)
9003700-100	Multi-Unit Abutment Analog (100-Pack)
9003703	Multi-Unit Abutment Digital Analog
9003703-10	Multi-Unit Abutment Digital Analog (10-Pack)
9003730	Multi-Unit Verification Cylinder w/.050 Screw
9003730-10	Multi-Unit Verification Cylinder w/.050 Screw (10-Pack)
9003730-50	Multi-Unit Verification Cylinder w/.050 Screw (50-Pack)
9003730-100	Multi-Unit Verification Cylinder w/.050 Screw (100-Pack)

Multi-Unit Compatible

## Multi-Unit Components (cont'd)

Item #	Product
9003731	Multi-Unit Verification Cylinder w/.048 Screw
9003731-10	Multi-Unit Verification Cylinder w/.048 Screw (10-Pack)
9003731-50	Multi-Unit Verification Cylinder w/.048 Screw (50 Pack)
9003731-100	Multi-Unit Verification Cylinder w/.048 Screw (100 Pack)
9003732	Multi-Unit Verification Cylinder w/Unigrip Screw
9003732-10	Multi-Unit Verification Cylinder w/Unigrip Screw (10-Pack)
9003732-50	Multi-Unit Verification Cylinder w/Unigrip Screw (50 Pack)
9003732-100	Multi-Unit Verification Cylinder w/Unigrip Screw (100 Pack)
9003733	Multi-Unit Verification Cylinder w/Neo Screw
9003733-10	Multi-Unit Verification Cylinder w/Neo Screw (10-Pack)
9003733-50	Multi-Unit Verification Cylinder w/Neo Screw (50-Pack)
9003733-100	Multi-Unit Verification Cylinder w/Neo Screw (100-Pack)
9003736	Multi-Unit Verification Cylinder w/SRA Screw
9003736-10	Multi-Unit Verification Cylinder w/SRA Screw (10-Pack)
9003736-50	Multi-Unit Verification Cylinder w/SRA Screw (50 Pack)
9003736-100	Multi-Unit Verification Cylinder w/SRA Screw (100 Pack)
9003795	ASC Multi-Unit x 9mm Non-Engaging Ti Base
9003752	ASC Multi-Unit Titanium Screw
9003762	Multi-Unit Ti Base w/.048 Screw
9003760	Multi-Unit Ti Base w/.050 Screw
9003761	Multi-Unit Ti Base w/SRA Screw
9003763	Multi-Unit Ti Base w/Unigrip Screw
9003768	Multi-Unit Ti Base w/Neo Screw
9003739	Multi-Unit Slim Tall Ti Base w/SRA Screw

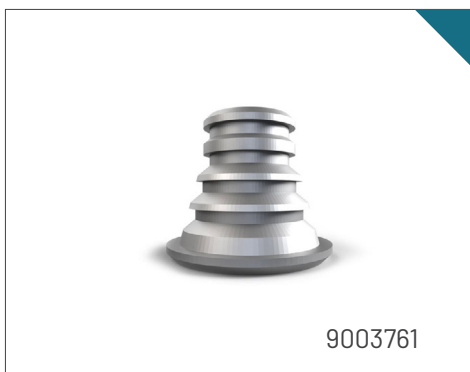
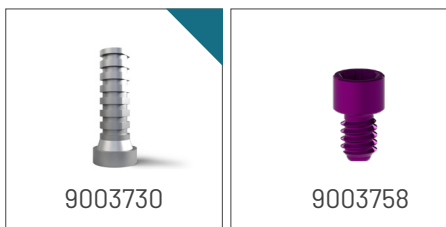

Multi-Unit Compatible

# IMPLANT PROSTHETICS

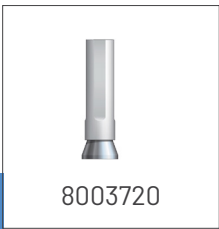
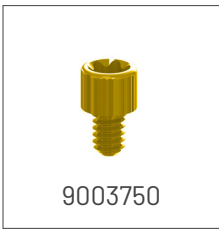
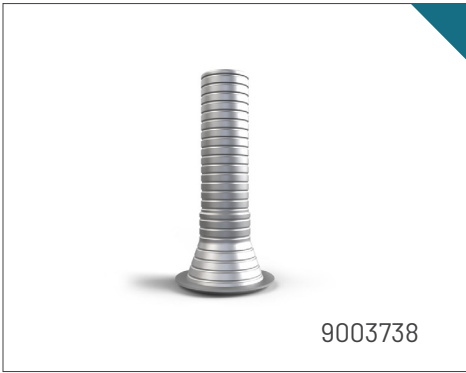

## Multi-Unit Components (cont'd)

Item #	Product
9003735	Multi-Unit Slim Tall Ti Base w/.048 Screw
9003738	Multi-Unit Slim Tall Ti Base w/.050 Hex Screw
9003737	Multi-Unit Slim Tall Ti Base w/Unigrip Screw
9003757	Multi-Unit Titanium Screw (.048 Hex)
9003757-10	Multi-Unit Titanium Screw (.048 Hex)(10-Pack)
9003751	Multi-Unit Titanium Screw (.050 Hex)
9003751-10	Multi-Unit Titanium Screw (.050 Hex)(10-Pack)
9003750	Multi-Unit Titanium Screw (Unigrip)
9003750-10	Multi-Unit Titanium Screw (Unigrip)(10-Pack)
9003758	Multi-Unit Screw (Neo)
9003758-10	Multi-Unit Screw (Neo)(10-Pack)
9003753	Multi-Unit Guide Pin
9000037	Multi-Unit Driver
8003725	Multi-Unit Gold Bar UCLA Coping
8003720	Multi-Unit Gold / Plastic UCLA Coping
8003710	Multi-Unit Abutment Plastic UCLA Coping
9003704	Bidra Conversion Smart Polishing Cap
9003704-4	Bidra Conversion Smart Polishing Cap (4-pack)
9003705	Bidra Smart Polishing Cap Short
9003705-4	Bidra Smart Polishing Cap Short (4-pack)

Multi-Unit Compatible

## THE BIDRA CONVERSION SMART POLISHING CAP

With an extended metal rim, **the Bidra Conversion Smart Polishing Cap fully protects both the inside and outside of the metal coping**, preventing damage to the coping when setting the acrylic, and while trimming, polishing and finishing the prosthesis.

External rough areas attract bacteria and may lead to soft tissue inflammation and bone loss around the implants.

Existing polishing caps only protect the inside of the coping, not the outside.

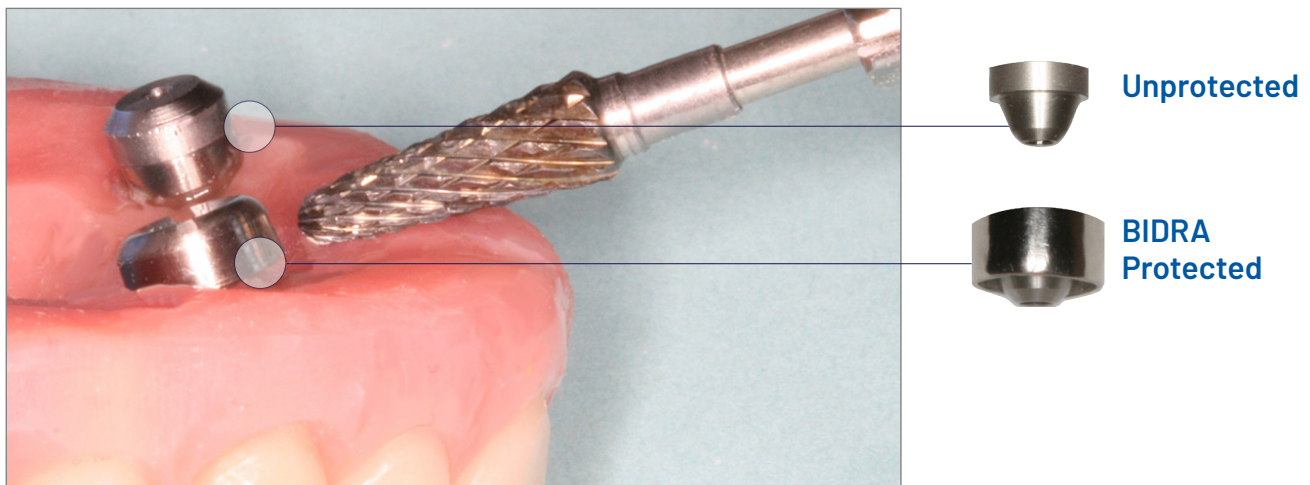

## Protect Your Next Full Arch Implant Conversion



# IMPLANT PROSTHETICS

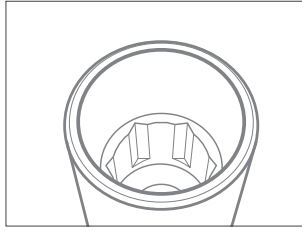

Compatible with  
Neodent® Helix™ GM



## Neodent® Helix™ GM

Item #	Product
9007121	2mm Healing Abutment
9007122	2mm Healing Abutment (Wide)
9007123	4mm Healing Abutment
9007124	4mm Healing Abutment (Wide)
9007101	Open-Tray Transfer
9007104	Closed-Tray Transfer
9007152	Closed-Tray Pin
9007145	Preat Choice Titanium Scan Body
9007100	Analog
9007100-10	Analog (10-Pack)
9007100-25	Analog (25-Pack)
9007103	Digital Analog
9007103-10	Digital Analog (10-Pack)
9007130	Engaging Verification Cylinder

Neodent® Helix™ GM Compatible



## Neodent® Helix™ GM (cont'd)

Item #	Product
9007130-10	Engaging Verification Cylinder (10-Pack)
9007135	Non-Engaging Verification Cylinder
9007135-10	Non-Engaging Verification Cylinder (10-Pack)
9007190	ASC 9mm Engaging Ti Base
9007195	ASC 9mm Non-Engaging Ti Base
9007153	ASC Titanium Screw
9007159	4.5mm Non-Engaging Ti Base
9007161	4.5mm Engaging Ti Base
9007162	6mm Engaging Ti Base
9007150	Titanium Screw
9007150-10	Titanium Screw (10-Pack)
9007151	Guide Pin
9007165	ASC Neodent® GM™-compatible Titanium Blank
9007167	Neodent® GM™-compatible Titanium Blank

Neodent® Helix™ GM Compatible

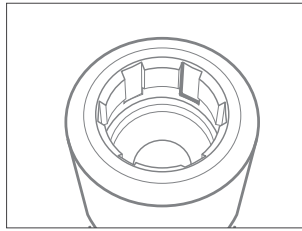

Compatible with  
**Neoss®**

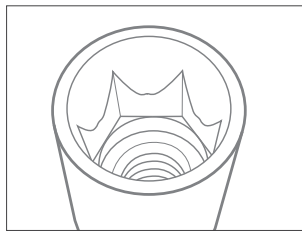

Compatible with  
**NobelActive™**

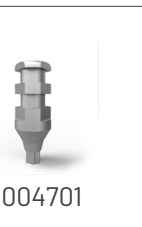

9004701



9004704



9004745



9004700

## Neoss® Regular Platform 3.5 / 4.0 / 4.5 / 5.0 / 5.5 mm

Item #	Product
9004145	3.5-6.0mm Preat Choice Titanium Scan Body <i>(for Preat Custom Solutions)</i>
9004100	Analog
9004100-10	10 Analog (10-Pack)
9004100-25	25 Analog (25-Pack)
9004103	Digital Analog
9004153	ASC 3.5mm-6.0mm Titanium Screw
9004165	ASC Neoss®-compatible 3.5-6.0mm Titanium Blank
9004167	Neoss®-compatible 3.5-6.0mm Titanium Blank

## NobelActive / Conical Connection 3.0mm

Item #	Product
9004701	3.0mm Open-Tray Transfer Nobel Biocare®
9004704	3.0mm Closed Tray Impression Coping Nobel Biocare®
9004745	3.0mm Preat Choice Titanium Scan Body
9004700	3.0mm Analog
9004700-10	3.0mm Analog (10-Pack)
9004700-25	3.0mm Analog (25-Pack)
9004703	3.0mm Digital Analog
9004721	3.0mm X 2mm Healing Abutment
9004722	3.0mm X 2mm Healing Abutment (Wide)
9004723	3.0mm X 4mm Healing Abutment
9004724	3.0mm X 4mm Healing Abutment (Wide)
8004730	3.0mm Engaging Verification Cylinder
8004730-10	3.0mm Engaging Verification Cylinder (10-Pack)
8004735	3.0mm Non-Engaging Verification Cylinder
8004715	3.0mm Non-Engaging Plastic UCLA

Neoss® Regular Platform 3.5 / 4.0 / 4.5 / 5.0 / 5.5 mm Compatible

NobelActive / Conical Connection 3.0mm Compatible

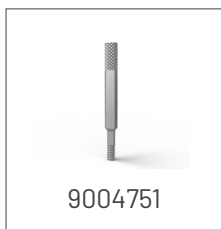
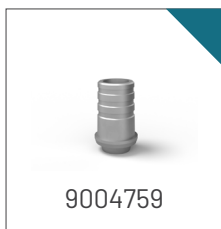

## NobelActive / Conical Connection 3.0mm (cont'd)

Item #	Product
9004735-10	3.0mm Non-Engaging Verification Cylinder (10-Pack)
9004790	ASC 9.0mm Engaging Ti Base
9004795	ASC 9.0mm Non-Engaging Ti Base
004753	ASC 3.0mm Screw
9004759	3.0mm Non-Engaging Ti Base x 4.5mm
9004761	3.0mm Engaging Ti Base x 4.5mm
9004762	3.0mm Engaging Ti Base x 6.0mm
9004750	3.0mm Titanium Screw
9004750-10	3.0mm Titanium Screw (10-Pack)
9004751	3.0mm Guide Pin 20mm
9004752	3.0mm Closed-Tray Pin
8004786	3.0mm Straight Multi-Unit Abutment x 2.5mm
8004787	3.0mm Straight Multi-Unit Abutment x 3.5mm
8004770	3.0mm Esthetic Abutment 15° Angle, Anterior
8004771	3.0mm Esthetic Abutment Straight, Anterior
8004720	3.0mm Engaging Gold / Plastic UCLA Abutment
8004710	3.0mm Engaging Plastic UCLA
8004725	3.0mm Non-Engaging Gold / Plastic UCLA Abutment
8004715	3.0mm Non-Engaging Plastic UCLA
9004765	3.0mm ASC NobelActive™/Conical-compatible Titanium Blank
9004767	3.0mm NobelActive™/Conical-compatible Titanium Blank

# IMPLANT PROSTHETICS



## NobelActive / Conical Connection NP 3.5mm

Item #	Product
8000818	Healing Abutment 4 x 3mm
8000819	Healing Abutment 4 x 5mm
8000801	Open Tray Transfer
8000804	Closed Tray Transfer
9000845	Preat Choice Titanium Scan Body
9000800	Analog
9000800-10	Analog (10-Pack)
9000800-25	Analog (25-Pack)
9000803	Digital Analog
9000803-10	Digital Analog (10-Pack)
9000830	Engaging Verification Cylinder
9000830-10	Engaging Verification Cylinder (10-Pack)
9000835	Non-Engaging Verification Cylinder
9000835-10	Non-Engaging Verification Cylinder (10-Pack)
9000890	ASC 9mm Engaging Ti Base
9000895	ASC 9mm Non-Engaging Ti Base
9000853	ASC Titanium Screw
9000859	Non-Engaging Ti Base x 4.5mm
9000861	Engaging Ti Base x 4.5mm

NobelActive / Conical Connection NP 3.5mm Compatible

## NobelActive / Conical Connection NP 3.5mm (cont'd)

Item #	Product
9000862	Engaging Ti Base x 6mm
9000850	Titanium Screw
9000850-10	Titanium Screw (10-Pack)
9000851	Guide Pin 20mm
8000889	Multi-Unit Titanium Screw
8000880	17° Multi-Unit Abutment x 2.5mm
8000881	17° Multi-Unit Abutment x 3.5mm
8000885	30° Multi-Unit Abutment x 3.5mm
8000886	30° Multi-Unit Abutment x 4.5mm
8000875	Straight Multi-Unit Abutment x 1.5mm
8000876	Straight Multi-Unit Abutment x 2.5mm
8000877	Straight Multi-Unit Abutment x 3.5mm
8000870	Esthetic Abutment 15° Angle, Anterior
8000871	Esthetic Abutment Straight, Anterior
8000825	Engaging Gold / Plastic UCLA Abutment
8000810	Engaging Plastic UCLA
8000820	Non-Engaging Gold / Plastic UCLA Abutment
8000815	Non-Engaging Plastic UCLA
9000865	ASC NobelActive™/Conical-compatible NP Titanium Blank
9000867	NobelActive™/Conical-compatible NP Titanium Blank

NobelActive / Conical Connection NP 3.5mm Compatible

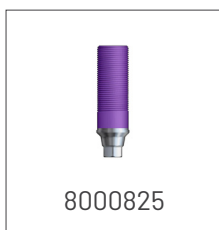
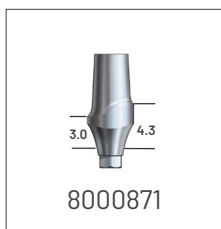
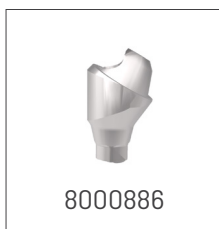

# IMPLANT PROSTHETICS

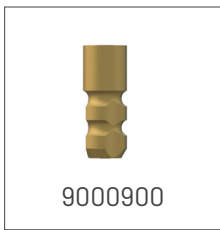
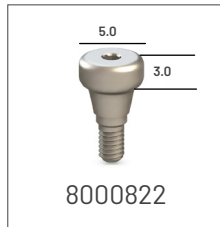

## NobelActive / Conical Connection RP 4.3 / 5.0mm

Item #	Product
8000822	Healing Abutment 5 x 3mm
8000823	Healing Abutment 5 x 5mm
8000901	Open Tray Transfer
8000904	Closed Tray Transfer
9000945	Preat Choice Titanium Scan Body
9000900	Analog
9000900-10	Analog (10-Pack)
9000900-25	Analog (25-Pack)
9000903	Digital Analog
9000903-10	Digital Analog (10-Pack)
9000930	Engaging Verification Cylinder
9000930-10	Engaging Verification Cylinder (10-Pack)
9000935	Non-Engaging Verification Cylinder
9000935-10	Non-Engaging Verification Cylinder (10-Pack)
9000990	ASC x 9mm Engaging Ti Base
9000995	ASC x 9mm Non-Engaging Ti Base
9000953	ASC Titanium Screw
9000959	Non-Engaging Ti Base x 4.5mm
9000961	Engaging Ti Base x 4.5mm
9000962	Engaging Ti Base x 6mm

NobelActive / Conical Connection RP 4.3 / 5.0mm Compatible

NobelActive / Conical Connection RP 4.3 / 5.0mm Compatible

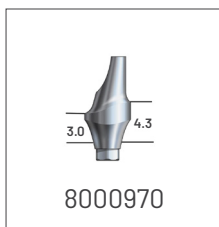

## NobelActive / Conical Connection RP 4.3 / 5.0mm (cont'd)

Item #	Product
9000950	Titanium Screw
9000950-10	Titanium Screw (10-Pack)
9000951	Guide Pin 20mm
8000989	Multi-Unit Titanium Screw
8000980	17° Multi-Unit Abutment x 2.5mm
8000981	17° Multi-Unit Abutment x 3.5mm
8000985	30° Multi-Unit Abutment x 3.5mm
8000986	30° Multi-Unit Abutment x 4.5mm
8000975	Straight Multi-Unit Abutment x 1.5mm
8000976	Straight Multi-Unit Abutment x 2.5mm
8000977	Straight Multi-Unit Abutment x 3.5mm
8000978	Straight Multi-Unit Abutment x 4.5mm
8000970	Esthetic Abutment 15° Angle, Anterior
8000972	Esthetic Abutment 15° Angle, Posterior
8000971	Esthetic Abutment Straight, Anterior
8000973	Esthetic Abutment Straight, Posterior
8000920	Engaging Gold / Plastic UCLA Abutment
9000910	Engaging Plastic UCLA
8000925	Non-Engaging Gold / Plastic UCLA Abutment
8000915	Non-Engaging Plastic UCLA
9000965	ASC NobelActive™/Conical-compatible RP Titanium Blank
9000967	NobelActive™/Conical-compatible RP Titanium Blank

# IMPLANT PROSTHETICS

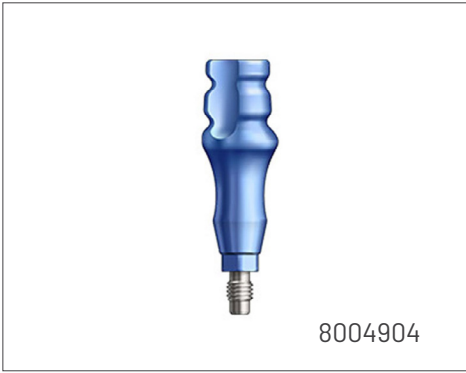

## NobelActive / Conical Connection WP

Item #	Product
8004901	Open Tray Transfer
8004904	Closed Tray Impression Coping
8004941	Scan Body (for use with Ti Bases)
9004900	Analog
9004900-10	Analog (10-Pack)
9004900-25	Analog (25-Pack)
9004903	Digital Analog
9004903-10	Digital Analog (10-Pack)
8004935	Non-Engaging Verification Cylinder
8004935-10	Non-Engaging Verification Cylinder (10-Pack)
8004930	Engaging Verification Cylinder
8004930-10	Engaging Verification Cylinder (10-Pack)
8004959	Non-Engaging Ti Base x 4.5mm
8004961	Engaging Ti Base x 4.5mm
8004962	Engaging Ti Base x 6mm
8004972	Esthetic Abutment Straight, Posterior
8004920	Engaging Gold / Plastic UCLA Abutment
8004910	Engaging Plastic UCLA
8004925	Non-Engaging Gold / Plastic UCLA Abutment
8004915	Non-Engaging Plastic UCLA

NobelActive / Conical Connection WP Compatible

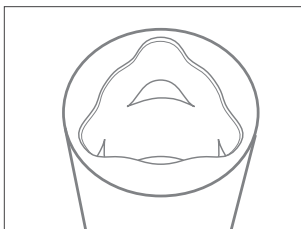

Compatible with  
NobelBiocare™ Tri-Lobe

NobelBiocare Tri-Lobe NP Compatible



## NobelBiocare Tri-Lobe NP

Item #	Product
8000401	Open-Tray Transfer 3.5mm
8000404	Closed-Tray Transfer 3.5mm
9000445	Preat Choice Titanium Scan Body
9000400	Analog
9000400-10	Analog (10-Pack)
9000400-25	Analog (25-Pack)
9000403	Digital Analog
9000403-10	Digital Analog (10-Pack)
9000430	Engaging Verification Cylinder
9000430-10	Engaging Verification Cylinder (10-Pack)
9000435	Non-Engaging Verification Cylinder
9000435-10	Non-Engaging Verification Cylinder (10-Pack)
9000453	ASC Titanium Screw
9000459	Non-Engaging Ti Base x 4.5mm
9000461	Engaging Ti Base x 4.5mm

# IMPLANT PROSTHETICS

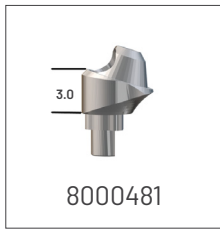

## NobelBiocare Tri-Lobe NP (cont'd)

Item #	Product
9000462	Engaging Ti Base x 6mm
9000450	Titanium Screw
9000450-10	Titanium Screw (10-Pack)
9000451	Guide Pin 20mm
8000480	17° Multi-Unit Abutment x 2mm
8000481	17° Multi-Unit Abutment x 3mm
8000475	Straight Multi-Unit Abutment x 1mm
8000476	Straight Multi-Unit Abutment x 2mm
8000477	Straight Multi-Unit Abutment x 3mm
8000470	Esthetic Abutment 15° Angle, Anterior
8000471	Esthetic Abutment Straight, Anterior
8000420	Engaging Gold / Plastic UCLA Abutment
8000410	Engaging Plastic UCLA
8000415	Non-Engaging Plastic UCLA
9000765	ASC NobelBiocare™ Tri-Lobe-compatible NP Titanium Blank
9000767	NobelBiocare™ Tri-Lobe-compatible NP Titanium Blank

NobelBiocare Tri-Lobe NP Compatible



## NobelBiocare Tri-Lobe RP

Item #	Product
8000501	Open-Tray Transfer 4.3mm
8000504	Closed-Tray Transfer 4.3mm
9000545	Preat Choice Titanium Scan Body
9000500	Analog
9000500-10	Analog (10-Pack)
9000500-25	Analog (25-Pack)
9000503	Digital Analog
9000503-10	Digital Analog (10-Pack)
9000530	Engaging Verification Cylinder
9000530-10	Engaging Verification Cylinder (10-Pack)
9000535	Non-Engaging Verification Cylinder
9000535-10	Non-Engaging Verification Cylinder (10-Pack)
9000590	ASC x 9mm Engaging Ti Base <i>(not currently for sale)</i>
9000595	ASC x 9mm Non-Engaging Ti Base <i>(not currently for sale)</i>
9000553	ASC Titanium Screw
9000559	Non-Engaging Ti Base x 4.5mm
9000561	Engaging Ti Base x 4.5mm
9000562	Engaging Ti Base x 6mm
9000550	Titanium Screw

# IMPLANT PROSTHETICS

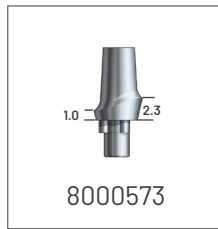
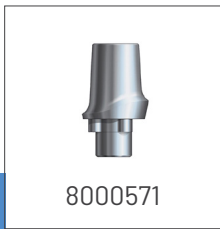

## NobelBiocare Tri-Lobe RP (cont'd)

Item #	Product
9000550-10	Titanium Screw (10-pack)
9000551	Guide Pin 20mm
8000589	Multi-Unit Titanium Screw
8000575	Straight Multi-Unit Abutment x 1mm
8000576	Straight Multi-Unit Abutment x 2mm
8000577	Straight Multi-Unit Abutment x 3mm
8000579	Straight Multi-Unit Abutment x 5mm
8000580	17° Multi-Unit Abutment x 2mm
8000581	17° Multi-Unit Abutment x 3mm
8000582	17° Multi-Unit Abutment x 4mm
8000586	30° Multi-Unit Abutment x 4mm
8000587	30° Multi-Unit Abutment x 5mm
8000570	Esthetic Abutment 15° Angle, Anterior
8000572	Esthetic Abutment 15° Angle, Posterior
8000571	Esthetic Abutment Straight, Anterior
8000573	Esthetic Abutment Straight, Posterior
8000520	Engaging Gold / Plastic UCLA Abutment
8000510	Engaging Plastic UCLA
8000515	Non-Engaging Plastic UCLA
9000565	ASC NobelBiocare™ Tri-Lobe-compatible RP Titanium Blank
9000567	NobelBiocare™ Tri-Lobe-compatible RP Titanium Blank

NobelBiocare Tri-Lobe RP Compatible

NobelBiocare Tri-Lobe WP Compatible

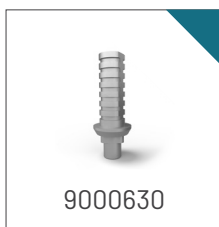
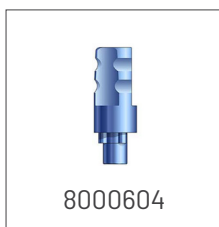

NobelBiocare Tri-Lobe WP	
Item #	Product
8000601	Open-Tray Transfer 5.0mm
8000604	Closed-Tray Transfer 5.0mm
9000645	Preat Choice Titanium Scan Body
9000600	Analog
9000600-10	Analog (10-Pack)
9000600-25	Analog (25-Pack)
9000603	Digital Analog
9000603-10	Digital Analog (10-Pack)
9000630	Engaging Verification Cylinder
9000630-10	Engaging Verification Cylinder (10-Pack)
9000635	Non-Engaging Verification Cylinder
9000635-10	Non-Engaging Verification Cylinder (10-Pack)
9000659	Non-Engaging Ti Base x 4.5mm
9000553	ASC Titanium Screw
9000690	ASC x 9mm Engaging Ti Base <i>(not currently for sale)</i>
9000695	ASC x 9mm Non-Engaging Ti Base <i>(not currently for sale)</i>
9000661	Engaging Ti Base x 4.5mm
9000662	Engaging Ti Base x 6mm
	Screws and Guide Pins - <a href="#">See page 132 &amp; 133</a>

# IMPLANT PROSTHETICS

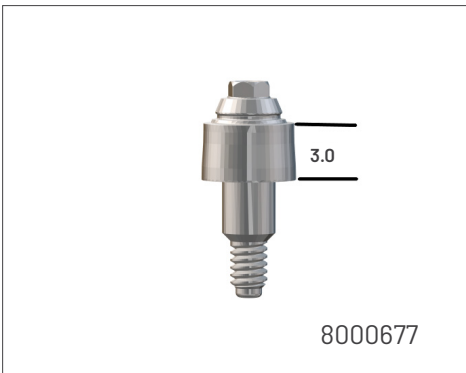

NobelBiocare Tri-Lobe WP (cont'd)	
Item #	Product
8000675	Straight Multi-Unit Abutment x 1mm
8000676	Straight Multi-Unit Abutment x 2mm
8000677	Straight Multi-Unit Abutment x 3mm
8000670	Esthetic Abutment 15° Angle, Anterior
8000672	Esthetic Abutment 15° Angle, Posterior
8000671	Esthetic Abutment Straight, Anterior
8000673	Esthetic Abutment Straight, Posterior
8000620	Engaging Gold / Plastic UCLA Abutment
8000610	Engaging Plastic UCLA
8000615	Non-Engaging Plastic UCLA
9000665	ASC NobelBiocare™ Tri-Lobe-compatible WP Titanium Blank
9000667	NobelBiocare™ Tri-Lobe-compatible WP Titanium Blank

NobelBiocare Tri-Lobe WP Compatible

NobelBiocare Tri-Lobe 6.0mm Compatible

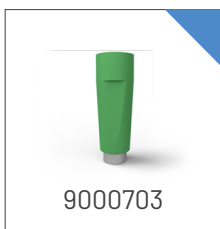
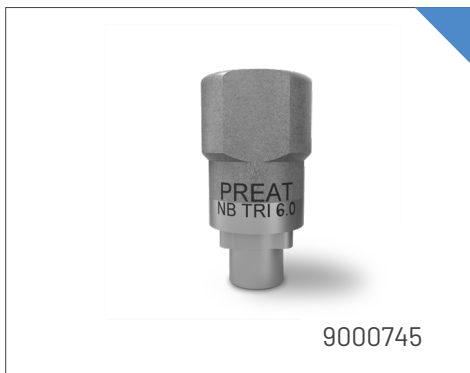

## NobelBiocare Tri-Lobe 6.0mm

Item #	Product
8000741	6.0mm Titanium Scan Body <i>(for use with Ti Bases)</i>
9000745	Preat Choice Titanium Scan Body <i>(for Preat Custom Solutions)</i>
9000700	6.0mm Analog
9000700-10	6.0mm Analog (10-Pack)
9000700-25	6.0mm Analog (25-Pack)
9000703	6.0mm Digital Analog
8000730	6.0mm Engaging Verification Cylinder
8000735	6.0mm Non-Engaging Verification Cylinder
8000759	6.0mm Non-Engaging Ti Base x 4.5mm
8000761	6.0mm Engaging Ti Base x 4.5mm
8000762	6.0mm Engaging Ti Base x 6mm
8000773	6.0mm Esthetic Abutment Straight, Posterior
8000720	6.0mm Engaging Gold / Plastic UCLA Abutment
8000710	6.0mm Engaging Plastic UCLA
8000715	6.0mm Non-Engaging Plastic UCLA
9000765	ASC NobelBiocare™ Tri-Lobe-compatible 6.0mm Titanium Blank
9000767	NobelBiocare™ Tri-Lobe-compatible 6.0mm Titanium Blank

# IMPLANT PROSTHETICS

## NobelBiocare Implant Systems

Steri-Oss Hex Lock 3.8 / 4.5mm	<i>Please see Nobel Branemark RP</i>
--------------------------------	--------------------------------------

## Southern Implant Systems

Southern 12 Degrees 4.3 (3.5mmD)	<i>Please see Nobel Tri-Lobe NP</i>
Southern 12 Degrees 5.0 (4.3mmD)	<i>Please see Nobel Tri-Lobe RP</i>
Southern 12 Degrees 7.0 (5.0mmD)	<i>Please see Nobel Tri-Lobe WP</i>
Southern CoAxis / MAX-IT 4.0 / 5.0mm (4.8mmD)	<i>Please see Straumann Tissue Level RN</i>
Southern CoAxis / MAX-IT 6.0 / (6.5mmD)	<i>Please see Straumann Tissue Level WN</i>
Southern CoAxis TriNeck / TriMax 6.0	<i>Please see Nobel Tri-Lobe 6.0</i>
Southern CoAxis TriNeck / TriMax NP	<i>Please see Nobel Tri-Lobe NP</i>
Southern CoAxis TriNeck / TriMax RP	<i>Please see Nobel Tri-Lobe RP</i>
Southern CoAxis TriNeck / TriMax WP	<i>Please see Nobel Tri-Lobe WP</i>

## Sterngold Implant Systems

Sterngold IC 3.3 / 4.1 / 4.8mm	<i>Please see Straumann Tissue Level RN</i>
Sterngold PUR NP	<i>Please see Zimmer TSV 3.5</i>
Sterngold PUR RP	<i>Please see Zimmer TSV 4.5</i>
Sterngold TRU NP	<i>Please see NobelActive / Conical NP</i>
Sterngold TRU RP	<i>Please see NobelActive / Conical RP</i>
Hex Cylinder 3.3 / 4.0mm	<i>Please see Nobel Branemark RP</i>
Hex Screws 3.75 / 4.0 / 5.0mm	<i>Please see Nobel Branemark RP</i>

NobelBiocare Implant System

Southern Implant System

Sterngold Implant System

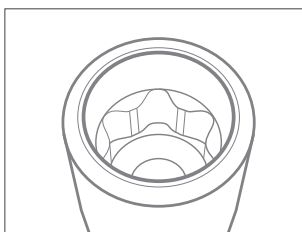

Compatible with  
Straumann® BLX

## Straumann® BLX RB/WB

Item #	Product
9007021	2mm Healing Abutment
9007022	2mm Healing Abutment (Wide)
9007023	4mm Healing Abutment
9007024	4mm Healing Abutment (Wide)
9007001	Open-Tray Transfer
9007004	Closed-Tray Transfer
9007045	Preat Choice Titanium Scan Body
9007000	Analog
9007000-10	Analog (10-Pack)
9007000-25	Analog (25-Pack)
9007003	Digital Analog
9007003-10	Digital Analog (10-Pack)
9007030	Engaging Verification Cylinder
9007030-10	Engaging Verification Cylinder (10-Pack)
9007035	Non-Engaging Verification Cylinder
9007035-10	Non-Engaging Verification Cylinder (10-Pack)
9007090	ASC 9mm Engaging Ti Base
9007095	ASC 9mm Non-Engaging Ti Base

Straumann® BLX RB/WB Compatible

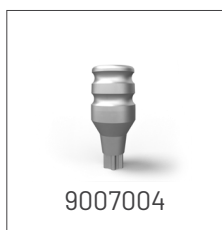

# IMPLANT PROSTHETICS

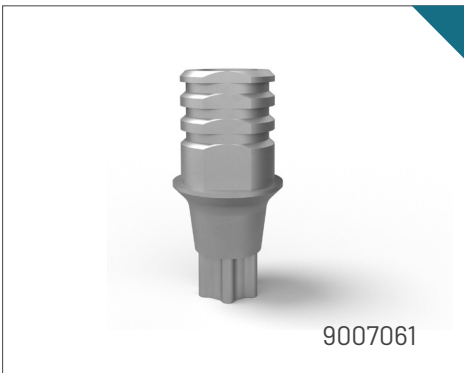

## Straumann® BLX RB/WB (cont'd)

Item #	Product
9007053	ASC Titanium Screw
9007059	Non-Engaging Ti Base x 4.5mm
9007061	Engaging Ti Base x 4.5mm
9007062	Engaging Ti Base x 6mm
9007050	Titanium Screw
9007050-10	Titanium Screw (10-Pack)
9007051	Guide Pin
9007065	ASC Straumann <sup>®</sup> ™ BLX-compatible RB/WB Titanium Blank
9007067	Straumann <sup>®</sup> BLX-compatible RB/WB Titanium Blank

Straumann® BLX RB/WB Compatible

## Straumann® BLX WB

Item #	Product
9007221	Healing Abutment x 2mm
9007223	Healing Abutment x 4mm
9007201	Open-Tray Transfer
9007204	Closed-Tray Transfer
9007245	Preat Choice Titanium Scan Body
9007200	Analog
9007200-10	Analog (10-Pack)
9007200-25	Analog (25-Pack)
9007203	Digital Analog
9007203-10	Digital Analog (10-Pack)
9007230	Engaging Verification Cylinder
9007235	Non-Engaging Verification Cylinder
9007259	Non-Engaging Ti Base x 4.5mm
9007261	Engaging Ti Base x 4.5mm
9007262	Engaging Ti Base x 6mm
9007290	ASC x 9mm Engaging Ti Base
9007295	ASC x 9mm Non-Engaging Ti Base
9007230-10	Eng. Verification Cylinder (10-Pack)
9007235-10	Non-Eng. Verification Cylinder (10-Pack)
9007265	ASC Straumann® BLX-compatible WB Titanium Blank
9007267	Straumann® BLX-compatible WB Titanium Blank

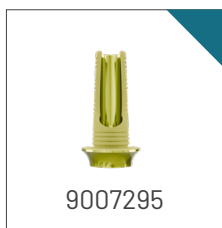

Straumann® BLX WB Compatible

# IMPLANT PROSTHETICS

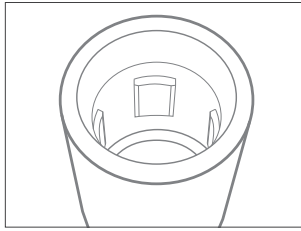

Compatible with  
Straumann® Bone Level



## Straumann® Bone Level NC (Narrow Crossfit, 3.3mm)

Item #	Product
8001521	Healing Abutment 4.8 x 3mm
8001523	Healing Abutment 4.8 x 5mm
8001504	Closed Tray Impression Tray Coping Slim
9001545	Preat Choice Titanium Scan Body
9001500	Analog
9001500-10	Analog (10-Pack)
9001500-25	Analog (25-Pack)
9001503	Digital Analog
9001503-10	Digital Analog (10-Pack)
9001530	Engaging Verification Cylinder
9001530-10	Engaging Verification Cylinder (10-Pack)
9001535	Non-Engaging Verification Cylinder
9001535-10	Non-Engaging Verification Cylinder (10-Pack)
9001590	ASC 9mm Engaging Ti Base
9001595	ASC 9mm Non-Engaging Ti Base

Straumann® Bone Level NC (Narrow Crossfit, 3.3mm) Compatible

Straumann® Bone Level NC (Narrow Crossfit, 3.3mm) Compatible



9001553



9001550



9001551



8001576



8001580



9001565

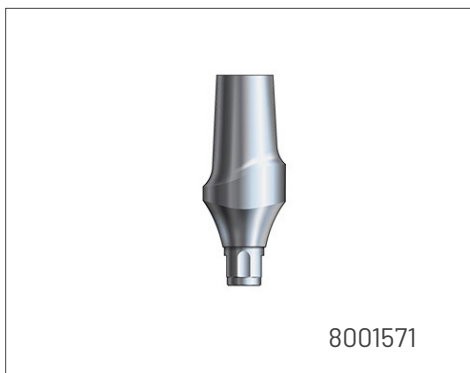

8001571

## Straumann® Bone Level NC (Narrow Crossfit, 3.3mm) (cont'd)

Item #	Product
9001553	ASC NC Titanium Screw
9001559	Non-Engaging Ti Base x 4.5mm
9001561	Engaging Ti Base x 4.5mm
9001562	Engaging Ti Base x 6.0mm
9001550	Titanium Screw
9001550-10	Titanium Screw (10-Pack)
9001551	Guide Pin 20mm
8001575	Straight Multi-Unit Abutment x 1.5mm
8001576	Straight Multi-Unit Abutment x 2.5mm
8001577	Straight Multi-Unit Abutment x 3.5mm
8001580	17° Multi-Unit Abutment x 2.5mm
8001581	17° Multi-Unit Abutment x 3.5mm
8001570	Esthetic Abutment 15° Angle, Anterior
8001571	Esthetic Abutment Straight, Anterior
8001510	Engaging Plastic UCLA
8001515	Non-Engaging Plastic UCLA
9001565	ASC Straumann® BL-compatible NC Titanium Blank
9001567	Straumann® BL-compatible NC Titanium Blank

# IMPLANT PROSTHETICS



## Straumann® Bone Level RC (Regular Crossfit, 4.1mm)

Item #	Product
8001421	Healing Abutment 6 x 3mm
8001423	Healing Abutment 6 x 5mm
8001404	Closed Tray Impression Tray Coping 4.5 x 9mm
9001445	Preat Choice Titanium Scan Body
9001400	Analog
9001400-10	Analog (10-Pack)
9001400-25	Analog (25-Pack)
9001403	Digital Analog
9001403-10	Digital Analog (10-Pack)
9001430	Engaging Verification Cylinder
9001430-10	Engaging Verification Cylinder (10-Pack)
9001435	Non-Engaging Verification Cylinder
9001435-10	Non-Engaging Verification Cylinder (10-Pack)
9001490	ASC 9mm Engaging Ti Base
9001495	ASC 9mm Non-Engaging Ti Base
9001453	ASC RC Titanium Screw
9001459	Non-Engaging Ti Base x 4.5mm
9001461	Engaging Ti Base x 4.5mm
9001462	Engaging Ti Base x 6mm
9001450	Titanium Screw

Straumann® Bone Level RC (Regular Crossfit, 4.1mm) Compatible

Straumann® Bone Level RC (Regular Crossfit, 4.1mm) Compatible

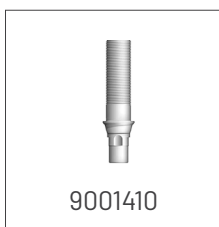
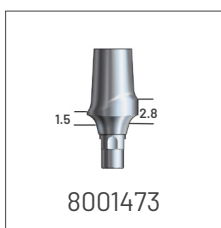
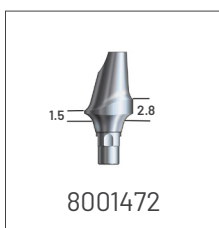
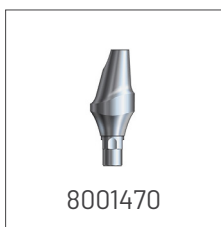
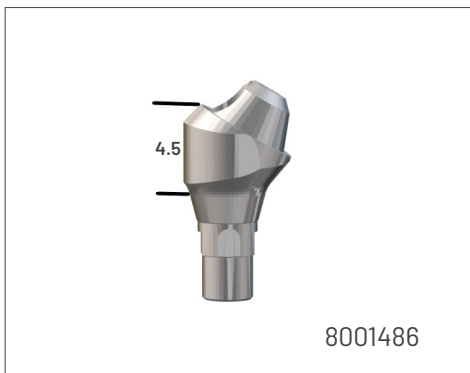

## Straumann Bone Level RC (Regular Crossfit, 4.1mm) (cont'd)

Item #	Product
9001450-10	Titanium Screw (10-Pack)
9001451	Guide Pin 20mm
9003756	Straumann Screw Receiving Abutment Screw 1.4mm
9003756-10	Screw Receiving Abutment Screw 1.4mm (10-Pack)
8001489	Multi-Unit Titanium Screw
8001480	17° Multi-Unit Abutment x 2.5mm
8001481	17° Multi-Unit Abutment x 3.5mm
8001485	30° Multi-Unit Abutment x 3.5mm
8001486	30° Multi-Unit Abutment x 4.5mm
8001482	30° Multi-Unit Abutment x 4.5mm
8001475	Straight Multi-Unit Abutment x 1.5mm
8001476	Straight Multi-Unit Abutment x 2.5mm
8001477	Straight Multi-Unit Abutment x 3.5mm
8001478	Straight Multi-Unit Abutment x 4.5mm
8001470	Esthetic Abutment 15° Angle, Anterior
8001472	Esthetic Abutment 15° Angle, Posterior
8001471	Esthetic Abutment Straight, Anterior
8001473	Esthetic Abutment Straight, Posterior
9001410	Engaging Plastic UCLA
8001415	Non-Engaging Plastic UCLA
9001465	ASC Straumann® BL-compatible RC Titanium Blank
9001467	Straumann® BL-compatible RC Titanium Blank

# IMPLANT PROSTHETICS

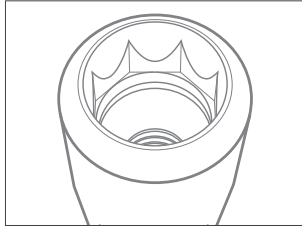

Compatible with  
Straumann® Tissue Level



## Straumann® Tissue Level NN (3.5mm Platform Diameter)

Item #	Product
8001100-10	Analog (10-Pack)
8001100-25	Analog (25-Pack)
8001150	Titanium Screw
8001150-10	Titanium Screw (10-Pack)



## Straumann® Tissue Level RN (4.8mm Platform Diameter)

Item #	Product
9001245	Preat Choice Titanium Scan Body
9001200	Analog
9001200-10	Analog (10-Pack)
9001200-25	Analog (25-Pack)
9001203	Digital Analog
9001203-10	Digital Analog (10-Pack)
9001230	Engaging Verification Cylinder
9001230-10	Engaging Verification Cylinder (10-Pack)
9001235	Non-Engaging Verification Cylinder
9001235-10	Non-Engaging Verification Cylinder (10-Pack)
9001290	ASC 9mm Engaging Ti Base
9001295	ASC 9mm Non-Engaging Ti Base



Straumann® Tissue Level NN (3.5mm Platform Diameter) Compatible

Straumann® Tissue Level RN (4.8mm Platform Diameter) Compatible

## Straumann® Tissue Level RN (4.8mm Platform Diameter) (cont'd)

Item #	Product
9001253	ASC RN/WN Titanium Screw
9001261	Engaging Ti Base x 4.5mm
9001259	Non-Engaging Ti Base x 4.5mm
9001262	Engaging Ti Base x 6mm
9001250	RN / WN Titanium Screw
9001250-10	RN / WN Titanium Screw (10-Pack)
9001251	Guide Pin
8001220	Engaging Gold / Plastic UCLA Abutment
8001225	Non-Engaging Gold / Plastic UCLA Abutment
9001265	ASC Straumann® TL-compatible RN Titanium Blank
9001267	Straumann® TL-compatible RN Titanium Blank

Straumann® Tissue Level RN (4.8mm Platform Diameter) Compatible



# IMPLANT PROSTHETICS

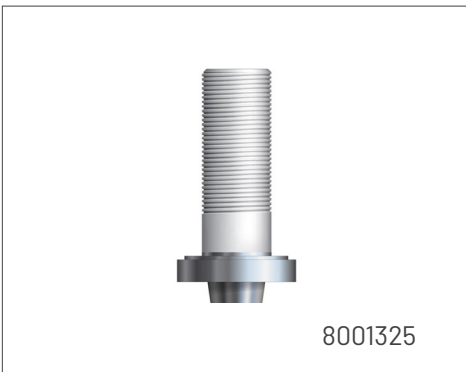

## Straumann Tissue Level WN (6.5mm Platform Diameter)

Item #	Product
8001341	Scan Body <i>(for use with Ti Bases)</i>
9001345	Preat Choice Titanium Scan Body <i>(for Preat Custom Solutions)</i>
9001300	Analog
9001300-10	Analog (10-Pack)
9001300-25	Analog (25-Pack)
9001303	Digital Analog
8001337	Non-Engaging Verification Cylinder
8001337-10	Non-Engaging Verification Cylinder (10-Pack)
8001331	Engaging Verification Cylinder
8001331-10	Engaging Verification Cylinder (10-Pack)
8001359	Non-Engaging Ti Base x 4.5mm
8001361	Engaging Ti Base x 4.5mm
8001362	Engaging Ti Base x 6mm
8001320	Engaging Gold / Plastic UCLA Abutment
8001325	Non-Engaging Gold / Plastic UCLA Abutment

Straumann Tissue Level WN (6.5mm Platform Diameter) Compatible

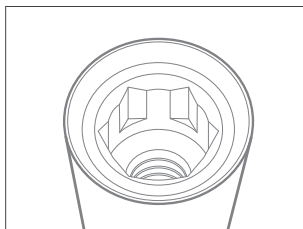

Compatible with  
Zimmer® Tapered Screw-Vent®



Zimmer Tapered Screw-Vent® 3.5mm Compatible

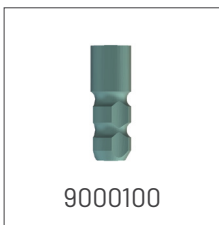
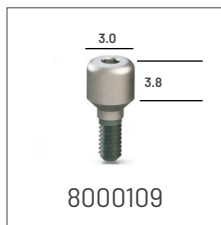

## Zimmer Tapered Screw-Vent® 3.5mm

Item #	Product
8000109	3.5mm Healing Abutment 3.8 x 3mm
8000119	3.5mm Healing Abutment 3.8 x 5mm
8000121	3.5mm Healing Abutment 4.5 x 3mm
8000123	3.5mm Healing Abutment 4.5 x 5mm
8000101	3.5mm Open-Tray Transfer 3.5 x 10mm
8000102	3.5mm Open-Tray Transfer 4.7 x 10mm
8000103	3.5mm Open-Tray Transfer Screw
8000106	3.5mm Closed-Tray Transfer Screw
8000104	3.5mm Closed-Tray Transfer 3.5 x 8mm
8000105	3.5mm Closed-Tray Transfer 4.7 x 8mm
9000145	3.5mm Preat Choice Titanium Scan Body
9000100	3.5mm Analog
9000100-10	3.5mm Analog (10-Pack)
9000100-25	3.5mm Analog (25-Pack)
9000103	3.5mm Digital Analog
9000103-10	3.5mm Digital Analog (10-Pack)
9000130	3.5mm Engaging Verification Cylinder
9000130-10	3.5mm Engaging Verification Cylinder (10-Pack)
9000135	3.5mm Non-Engaging Verification Cylinder
9000135-10	3.5mm Non-Engaging Verification Cylinder (10-Pack)
9000190	ASC 3.5mm x 9mm Engaging Ti Base
9000195	ASC 3.5mm x 9mm Non-Engaging Ti Base

# IMPLANT PROSTHETICS

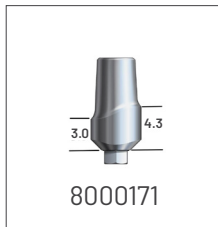
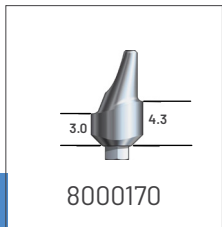

## Zimmer Tapered Screw-Vent® 3.5mm (cont'd)

Item #	Product
9000153	ASC 3.5mm/ 4.5mm/ 5.7mm Titanium Screw
9000159	3.5mm Non-Engaging Ti Base x 4.5mm
9000161	3.5mm Engaging Ti Base x 4.5mm
9000162	3.5mm Engaging Ti Base x 6mm
9000150	<u>3.5mm / 4.5mm / 5.7mm</u> Titanium Screw
9000150-10	<u>3.5mm / 4.5mm / 5.7mm</u> Titanium Screw (10-Pack)
9000151	<u>3.5mm / 4.5mm / 5.7mm</u> Guide Pin 20mm
8000189	<u>3.5mm / 4.5mm / 5.7mm</u> Multi Unit Titanium Screw
8000180	3.5mm 17° Multi-Unit Abutment x 2mm
8000181	3.5mm 17° Multi-Unit Abutment x 3mm
8000185	3.5mm 30° Multi-Unit Abutment x 3mm
8000175	3.5mm Straight Multi-Unit Abutment x 1mm
8000176	3.5mm Straight Multi-Unit Abutment x 2mm
8000170	3.5mm Esthetic Abutment 15° Angle, Anterior
8000171	3.5mm Esthetic Abutment Straight, Anterior
8000120	3.5mm Engaging Gold / Plastic UCLA Abutment
9000110	3.5mm Engaging Plastic UCLA
8000115	3.5mm Non-Engaging Plastic UCLA
9000165	ASC Zimmer® TSV-compatible 3.5mm Titanium Blank
9000167	Zimmer® TSV-compatible 3.5mm Titanium Blank

Zimmer Tapered Screw-Vent® 3.5mm Compatible

## Zimmer Tapered Screw-Vent® 4.5mm

Item #	Product
8000221	4.5mm Healing Abutment 5.5 x 3mm
8000223	4.5mm Healing Abutment 5.5 x 5mm
8000201	4.5mm Open-Tray Transfer 4.5 x 10mm
8000202	4.5mm Open-Tray Transfer 5.7 x 10mm
8000204	4.5mm Closed-Tray Transfer 4.5 x 8mm
8000205	4.5mm Closed-Tray Transfer 5.7 x 8mm
9000245	4.5mm Preat Choice Titanium Scan Body
9000200	4.5mm Analog
9000200-10	4.5mm Analog (10-Pack)
9000200-25	4.5mm Analog (25-Pack)
9000203	4.5mm Digital Analog
9000203-10	4.5mm Digital Analog (10-Pack)
9000230	4.5mm Engaging Verification Cylinder
9000230-10	4.5mm Engaging Verification Cylinder (10-Pack)
9000235	4.5mm Non-Engaging Verification Cylinder
9000235-10	4.5mm Non-Engaging Verification Cylinder (10-Pack)
9000290	ASC 4.5mm x 9mm Engaging Ti Base
9000295	ASC 4.5mm x 9mm Non-Engaging Ti Base

Zimmer Tapered Screw-Vent® 4.5mm Compatible



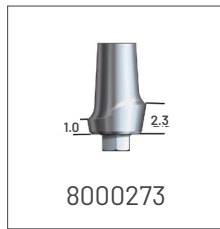
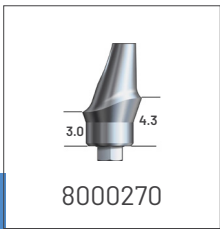

## Zimmer Tapered Screw-Vent® 4.5mm (cont'd)

Item #	Product
9000259	4.5mm Non-Engaging Ti Base x 4.5mm
9000261	4.5mm Engaging Ti Base x 4.5mm
9000262	4.5mm Engaging Ti Base x 6mm
	Screws and Guide Pins - <a href="#">See page 149</a>
8000275	4.5mm Straight Multi-Unit Abutment x 1mm
8000276	4.5mm Straight Multi-Unit Abutment x 2mm
8000277	4.5mm Straight Multi-Unit Abutment x 3mm
8000278	4.5mm Straight Multi-Unit Abutment x 5mm
8000280	4.5mm 17° Multi-Unit Abutment x 2mm
8000281	4.5mm 17° Multi-Unit Abutment x 3mm
8000283	4.5mm 17° Multi-Unit Abutment x 5mm
8000285	4.5mm 30° Multi-Unit Abutment x 3mm
8000286	4.5mm 30° Multi-Unit Abutment x 5mm
8000270	4.5mm Esthetic Abutment 15° Angle, Anterior
8000272	4.5mm Esthetic Abutment 15° Angle, Posterior
8000271	4.5mm Esthetic Abutment Straight, Anterior
8000273	4.5mm Esthetic Abutment Straight, Posterior
8000220	4.5mm Engaging Gold / Plastic UCLA Abutment
8000210	4.5mm Engaging Plastic UCLA
8000215	4.5mm Non-Engaging Plastic UCLA
9000265	ASC Zimmer® TSV-compatible 4.5mm Titanium Blank
9000267	Zimmer® TSV-compatible 4.5mm Titanium Blank

Zimmer Tapered Screw-Vent® 4.5mm Compatible

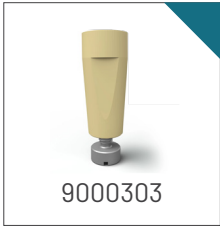

## Zimmer Tapered Screw-Vent® 5.7mm

Item #	Product
9000345	5.7mm Preat Choice Titanium Scan Body
9000300	5.7mm Analog
9000300-10	5.7mm Analog (10-Pack)
9000300-25	5.7mm Analog (25-Pack)
9000303	5.7mm Digital Analog
9000303-10	5.7mm Digital Analog (10-Pack)
9000335	5.7mm Non-Engaging Verification Cylinder
9000335-10	5.7mm Non-Engaging Verification Cylinder (10-Pack)
9000330	5.7mm Engaging Verification Cylinder
9000330-10	5.7mm Engaging Verification Cylinder (10-Pack)
9000390	ASC 5.7mm x 9mm Engaging Ti Base
9000395	ASC 5.7mm x 9mm Non-Engaging Ti Base
9000359	5.7mm Non-Engaging Ti Base x 4.5mm
9000361	5.7mm Engaging Ti Base x 4.5mm
9000362	5.7mm Engaging Ti Base x 6mm
	Screws and Guide Pins - See page 149
8000310	5.7mm Engaging Plastic UCLA
8000315	5.7mm Non-Engaging Plastic UCLA
9000365	ASC Zimmer® TSV-compatible 5.7mm Titanium Blank
9000367	Zimmer® TSV-compatible 5.7mm Titanium Blank

# IMPLANT BUDDY RESTORE 99% OF IMPLANT CASES

## Prosthetic Connection Included:

- Straight
- SCS
- UniGrip
- Hex 1.3mm/.050"
- Hex 1.2mm/.048"
- Hex 0.9mm/.035"
- ASC Angled Driver

### SMART THUMB KNOB

inserts directly onto torque driver

### SHORT & LONG DRIVERS

for each prosthetic screw connection

### TAPERED DRIVERS

for a stronger connection

### COLOR CODED

for easy ID



158

### AUTOCLAVABLE







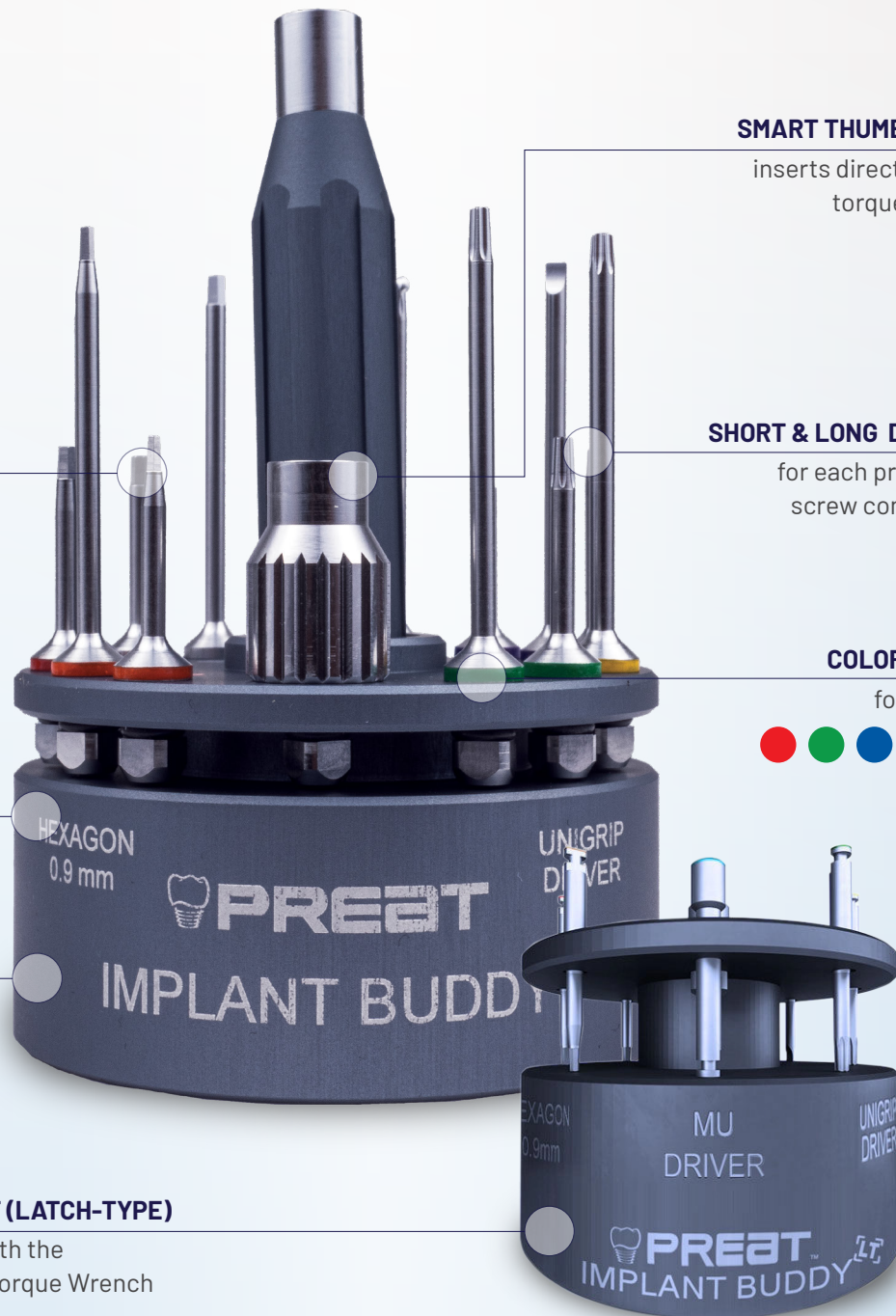

### MAGNETIC BASE

all components stay in place mount on any metallic surface

### IMPLANT BUDDY LT (LATCH-TYPE)

designed to work with the Omega Adjustable Torque Wrench



Driver / Prosthetic Connection	Systems
 Straight Driver	Straight Systems
 SCS Driver	Straumann®
 UniGrip Driver	NobelBiocare™
 Hex 1.3mm/.050 inch	Lifecore, BioHorizons®, Astra, Zimmer
 Hex 1.2mm/.048 inch	Biomet 3i, MegaGen®, Hiossen®
 Hex 0.9mm/.035 inch	Friadent, Ankylos 3i Cover Screw
 Angled Driver	ASC - Angulated Screw Channel
 Square 1.3mm/.050 inch	Gold Screw/NobelBiocare™



## Implant Components and Drivers

Item #	Product
9000000	Implant Buddy Driver Set
9000020	Omega Adjustable Torque Wrench: Works hand in hand with the Implant Buddy. This High Precision Calibrated Torque can adjust from 10 to 70 Ncm! Implant Buddy & Omega Wrench Set: Save when you buy the Implant Buddy Driver Set and Omega Torque Wrench Set together
4009020	30N-cm Torque and Thumb Knob Wrench Kit
4034391	20N-cm LOCATOR Torque and Thumb Knob Wrench Kit
1600035	Latch to Square Driver Insert
1600036	Square To Straumann Driver Insert
8000085	Cuff Height & Angulation Tool Set
8000080	Cuff Height Measuring Tool
9000041	Hand Driver

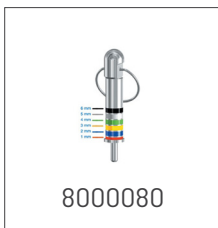

# IMPLANT DRIVERS & TOOLS

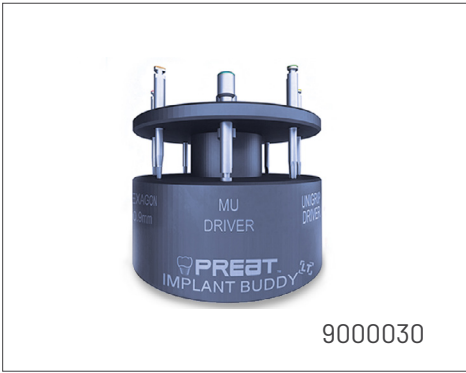

9000030



9000032



9000033



9000034



9000035



9000036



9000037

## Latch Type Drivers

Item #	Product
9000030	Implant Buddy LT - Latch-Type Driver Set
9000031	Latch-Type Straight Driver
9000032	Latch-Type SCS Driver
9000033	Latch-Type UniGrip Driver
9000034	Latch-Type .050 Hex Driver
9000035	Latch-Type .048 Hex Driver
9000036	Latch-Type .035 Hex Driver
9000037	Multi-Unit Latch Driver

## Square Type Drivers

Square Type Prosthetic Connection	Short Total Length 18mm Shaft Length 11mm	Medium Total Length 23mm Shaft Length 16mm	Long Total Length 39mm Shaft Length 32mm
— Straight Driver	8000051	9000061	9000071
★ SCS Driver	8000052	9000062	9000072
★ UniGrip Driver	8000053	9000063	9000073
● .050 Hex Driver	8000054	9000064	9000074
● .048 Hex Driver	8000055	9000065	9000075
● .035 Hex Driver	8000056	9000066	9000076
■ .050 Square Driver	8000057	8000067	8000077

THE CUFF HEIGHT AND ANGULATION SET\*

# The Must Have Tool for All Implant Professionals

## Stop Guessing Abutment Heights & Angulations

### EASY TO USE

1. Place the tool on top of the implant platform to measure gingival height.
2. Rotate angle measurement arm to identify if a straight abutment, 17° or 30° abutment is necessary.

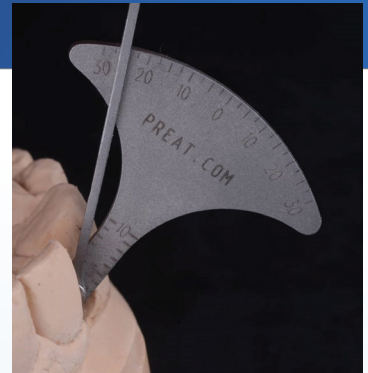
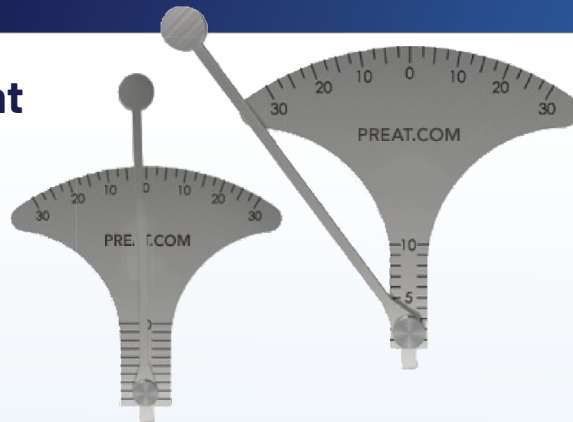

Item #8000085



Abutments Too High?



Abutments Too Low?

### See What our Customers Have to Say

*"This is a must have tool for anyone doing anything implant related. I use this tool daily!"*

- Sevan Pulurian, Pacific Dental

*"This tool really saves me time and confusion on large implant cases. It takes away all the guesswork and permits me to plant these cases accurately from the laboratory, allowing for the proper ordering of necessary components."*

- Joshua Polansky, MDC, Niche Dental Studio

*"When things get tough small tools can have a big impact. Using this one almost every day. Thank you PREAT, great development!"*

- Alexander Wünsche, Cdt, Zahntechnik Inc.

\*Set includes two diameters of the tool, allowing use on implants from 3mm to 6mm Ø.

## Implant Compatibility Chart

System	Compatible With	Page
3.5 (red), 4.0 (yellow), and 5.0mm (green)	OsseoLink Global Implant® Solutions OctaCone	
3I® Osseotite XP 3.75 & 4.1mm Standard	Nobel® Branemark® RP 3.75 / 4.1mm	<a href="#">94</a>
AB Dental® 3.75mm NP	Zimmer® Screw-Vent / Tapered Screw-Vent 3.3 / 3.7 / 4.1mm (3.5mm Ø)	<a href="#">148</a>
AB Dental® 4.50mm WP	Zimmer® Screw-Vent / Tapered Screw-Vent 4.7mm Diameter (4.5mm Ø)	<a href="#">150</a>
ACE® Infinity Internal Hex 3.7 / 4.1mm	Zimmer® Screw-Vent / Tapered Screw-Vent 3.3 / 3.7 / 4.1mm (3.5mm Ø)	<a href="#">148</a>
ACE® Infinity Internal Hex 4.7 / 5.1mm	Zimmer® Screw-Vent / Tapered Screw-Vent 4.7mm Diameter (4.5mm Ø)	<a href="#">150</a>
ACE® Infinity TRI-CAM 3.5mm	Nobel® Replace Tri-Lobe NP 3.5mm	<a href="#">130</a>
ACE® Infinity TRI-CAM 4.3mm	Nobel® Replace Tri-Lobe RP 4.3mm	<a href="#">132</a>
ACE® Infinity TRI-CAM 5.0mm	Nobel® Replace Tri-Lobe WP 5.0mm	<a href="#">134</a>
ACE® Infinity X-hex Implant 3.3mm	Nobel® Branemark NP 3.3mm	
ACE® Infinity X-hex Implant 3.7 / 4.0mm	Nobel® Branemark RP 3.75 / 4.1mm	<a href="#">94</a>
ACE® Infinity X-hex Implant 4.75mm	Nobel® Branemark WP 5.1mm	
Adin® Swell	Zimmer® Screw-Vent / Tapered Screw-Vent 3.3 / 3.7 / 4.1mm (3.5mm Ø)	<a href="#">148</a>
Adin® Touareg	Zimmer® Screw-Vent / Tapered Screw-Vent 3.3 / 3.7 / 4.1mm (3.5mm Ø)	<a href="#">148</a>
Alfa Gate® Bioactive	Zimmer® Screw-Vent / Tapered Screw-Vent 3.3 / 3.7 / 4.1mm (3.5mm Ø)	<a href="#">148</a>
Alfa Gate® DFCI 3.5mm	Zimmer® Screw-Vent / Tapered Screw-Vent 3.3 / 3.7 / 4.1mm (3.5mm Ø)	<a href="#">148</a>
Almitech Implant System®	Straumann® SynOcta (Tissue Level) Standard RN (4.8mmD)	<a href="#">145</a>
Alpha Bio® Internal Hex	Zimmer® Screw-Vent / Tapered Screw-Vent 3.3 / 3.7 / 4.1mm (3.5mm Ø)	<a href="#">148</a>
Alpha Dent® Active / Plus	Zimmer® Screw-Vent / Tapered Screw-Vent 3.3 / 3.7 / 4.1mm (3.5mm Ø)	<a href="#">148</a>
Alpha Dent® Bio	Zimmer® Screw-Vent / Tapered Screw-Vent 3.3 / 3.7 / 4.1mm (3.5mm Ø)	<a href="#">148</a>
Alpha Dent® Classic	Zimmer® Screw-Vent / Tapered Screw-Vent 3.3 / 3.7 / 4.1mm (3.5mm Ø)	<a href="#">148</a>
Alpha Dent® Conus	Zimmer® Screw-Vent / Tapered Screw-Vent 3.3 / 3.7 / 4.1mm (3.5mm Ø)	<a href="#">148</a>
American Dental Implant® Int. Hex Skinny 2.4 (3.5)	Zimmer® Screw-Vent / Tapered Screw-Vent 3.3 / 3.7 / 4.1mm (3.5mm Ø)	<a href="#">148</a>
American Dental Implant® Int. Hex Small (3.5)	Zimmer® Screw-Vent / Tapered Screw-Vent 3.3 / 3.7 / 4.1mm (3.5mm Ø)	<a href="#">148</a>
American Dental Implant® Int. Hex Wide (4.5)	Zimmer® Screw-Vent / Tapered Screw-Vent 4.7mm Diameter (4.5mm Ø)	<a href="#">150</a>
American Dental Implant® Int. Hex XL (5.7)	Zimmer® Screw-Vent / Tapered Screw-Vent 5.7mm	<a href="#">152</a>
ARDS® Classic 3.75mm	Zimmer® Screw-Vent / Tapered Screw-Vent 3.3 / 3.7 / 4.1mm (3.5mm Ø)	<a href="#">148</a>
AS Technology® c-fix Cone Morse Regular (4.8)	Straumann® SynOcta (Tissue Level) Standard RN (4.8mmD)	<a href="#">145</a>
AS Technology® e-fix Ext Hexagon-Narrow Plat. (3.5)	Straumann® SynOcta (Tissue Level) Standard NN (3.5mmD)	

All product names, logos, and brands are property of their respective owners. All company, product and service names are for identification purposes only. Use of these third-party names, logos, and brands does not imply, nor should it be understood as, any indication that the respective third-party brand owners have endorsed or sponsored, or are otherwise affiliated with or connected to, Preat or Preat's goods or services.

## Implant Compatibility Chart *(cont'd)*

System	Compatible With	Page
AS Technology® e-fix Ext Hexagon-Regular Platform (4.1)	Nobel® Branemark® RP 3.75 / 4.1mm	<a href="#">94</a>
AS Technology® e-fix Turque Interno-Regular Platform (4.1)	Nobel® Branemark® RP 3.75 / 4.1mm	<a href="#">94</a>
Avinent® Externa®	Nobel® Branemark® RP 3.75 / 4.1mm	<a href="#">94</a>
Avinent® HI/IC	Zimmer® Screw-Vent / Tapered Screw-Vent 3.3 / 3.7 / 4.1mm (3.5mm Ø)	<a href="#">148</a>
B&B Dental Conexa™	NobelBiocare™ NobelActive™/Conical NP	<a href="#">125</a>
B&W® External Hexagonal (5.0)	Biomet 3i® Osseotite XP 5.0mm WP	
B&W® External Hexagonal Cylindrical (3.3)	Steri-Oss® Hex Lock 3.25mm	
B&W® Tapered Morse MEI (4.8)	Straumann® SynOcta (Tissue Level) Standard RN (4.8mmD)	<a href="#">145</a>
Bioconcept® Tissue Level	Straumann® SynOcta (Tissue Level) Standard RN (4.8mmD)	<a href="#">145</a>
BioHorizon® Internal 3.5	Zimmer® Screw-Vent / Tapered Screw-Vent 3.3 / 3.7 / 4.1mm (3.5mm Ø)	<a href="#">148</a>
BioHorizon® Internal 4.5	Zimmer® Screw-Vent / Tapered Screw-Vent 4.7mm Diameter (4.5mm Ø)	<a href="#">150</a>
BioHorizon® Internal 5.7	Zimmer® Screw-Vent / Tapered Screw-Vent 5.7mm	<a href="#">152</a>
Biogenesis® Iticon	Straumann® SynOcta (Tissue Level) Standard RN (4.8mmD)	<a href="#">145</a>
BIO-LOK® 4.0mm IC (Silhouette)	Nobel® Branemark® RP 3.75 / 4.1mm	<a href="#">94</a>
BIO-LOK® External Hex	Nobel® Branemark® RP 3.75 / 4.1mm	<a href="#">94</a>
Biomain® Combine Narrow 3.5	Nobel® Replace Tri-Lobe NP 3.5mm	<a href="#">130</a>
Biomain® Combine Regular 4.3	Nobel® Replace Tri-Lobe RP 4.3mm	<a href="#">132</a>
Biomain® Combine Wide 5.0	Nobel® Replace Tri-Lobe WP 5.0mm	<a href="#">134</a>
Biomain® External Hexagon Narrow (3.5)	Nobel® Branemark® NP 3.3mm	
Biomain® External Hexagon Regular (4.1)	Nobel® Branemark® RP 3.75 / 4.1mm	<a href="#">94</a>
Biomain® External Hexagon Wide (5.1)	Nobel® Branemark® WP 5.1mm	
Biomain® I-Fix Regular (4.8)	Straumann® SynOcta (Tissue Level) Standard RN (4.8mmD)	<a href="#">145</a>
Bioner® Hikelt 3.8	Zimmer® Screw-Vent / Tapered Screw-Vent 3.3 / 3.7 / 4.1mm (3.5mm Ø)	<a href="#">148</a>
Bioner® Hikelt 4.5	Zimmer® Screw-Vent / Tapered Screw-Vent 4.7mm Diameter (4.5mm Ø)	<a href="#">150</a>
Bioner® TopDM	Nobel® Active / Conical Connection NP 3.5mm	<a href="#">125</a>
Bionnovation® Hexagono Ext HE Classic Cilindrico SP (3.3)	Steri-Oss® Hex Lock 3.25mm	
Bionnovation® Hexagono Externo HE Classic WP (5.0)	Intra-Lock® Threaded Conic 4.75/ 5.0mm Ex Hex	
Bionnovation® Hexagono Externo HE RP (4.1)	Nobel® Branemark® RP 3.75 / 4.1mm	<a href="#">94</a>
Biotec Korum® External (3.3) / TOP (3.4) / TRE (3.4)	Biomet 3i® 3.25mm & 3.3mm MicroMiniplant®	

The compatibility information referenced in these charts is based on published, available data and design equivalence. This information is intended to assist dental providers with treatment and diagnosis. Preat Corporation does not provide any diagnosis or suggested medical treatment in the report.

## Implant Compatibility Chart *(cont'd)*

System	Compatible With	Page
Biotec® Korum External / TOP / TRE (4.0)	Nobel® Branemark® RP 3.75 / 4.1mm	<a href="#">94</a>
Biotec® Korum External / TOP / TRE (5.0)	Biomet 3i® Osseotite XP 5.0mm WP	
Biotec® SPR/SPTT/CIM	Zimmer® Screw-Vent / Tapered Screw-Vent 3.3 / 3.7 / 4.1mm (3.5mm Ø)	<a href="#">148</a>
Blue Sky Bio® Conus 12 3.5/4.0	Astra® Tech Osseospeed 3.5/4.0s (AQUA)	<a href="#">79</a>
Blue Sky Bio® Conus 12 4.5/5.0	Astra® Tech Osseospeed 4.5/5.0s (LILAC)	<a href="#">81</a>
Blue Sky Bio® Forte	Nobel® Active / Conical Connection NP 3.5mm	<a href="#">125</a>
Blue Sky Bio® Internal Hex 3.5mm Green	Zimmer® Screw-Vent / Tapered Screw-Vent 3.3 / 3.7 / 4.1mm (3.5mm Ø)	<a href="#">148</a>
Blue Sky Bio® Internal Hex 4.5mm Purple	Zimmer® Screw-Vent / Tapered Screw-Vent 4.7mm Diameter (4.5mm Ø)	<a href="#">150</a>
Blue Sky Bio® One Stage RN (4.1mm)	Straumann® SynOcta (Tissue Level) Standard RN (4.8mmD)	<a href="#">145</a>
Blue Sky Bio® Three	Astra® Tech Osseospeed 3.0s	<a href="#">78</a>
Blue Sky Bio® Tri-Lobe 6.0mm	Nobel® Replace Tri-Lobe 6.0mm	<a href="#">136</a>
Blue Sky Bio® Tri-Lobe NP	Nobel® Replace Tri-Lobe NP 3.5mm	<a href="#">130</a>
Blue Sky Bio® Tri-Lobe RP	Nobel® Replace Tri-Lobe RP 4.3mm	<a href="#">132</a>
Blue Sky Bio® Tri-Lobe WP	Nobel® Replace Tri-Lobe WP 5.0mm	<a href="#">134</a>
Blue Sky® MAX	Nobel® Active / Conical Connection NP 3.5mm	<a href="#">125</a>
Branemark® Compatible		<a href="#">94</a>
BTI® Externa and Externa Plus RP	Nobel® Branemark® RP 3.75 / 4.1mm	<a href="#">94</a>
Calcitek® Threadlock 4.0mm	Nobel® Branemark® RP 3.75 / 4.1mm	<a href="#">94</a>
CORTEK® Dynamix/Classix/Saturn	Zimmer® Screw-Vent / Tapered Screw-Vent 3.3 / 3.7 / 4.1mm (3.5mm Ø)	<a href="#">148</a>
Cowell® Atlas Internal	Straumann® SynOcta (Tissue Level) Standard RN (4.8mmD)	<a href="#">145</a>
DENTIN® Classic, Prestige®, Rapid®	Zimmer® Screw-Vent / Tapered Screw-Vent 3.3 / 3.7 / 4.1mm (3.5mm Ø)	<a href="#">148</a>
Dentium®	Hiossen® Regular 4.0 / 4.5 / 5.0mm	<a href="#">105</a>
Dentis® Cleanlant	Hiossen® Regular 4.0/4.5/5.0mm	<a href="#">105</a>
DIO Implant UFII	Hiossen® Regular 4.0/4.5/5.0mm	<a href="#">105</a>
Ditron Dental MPI™	Zimmer® Screw-Vent/Tapered Screw-Vent 3.3/3.7/4.1mm (3.5mm)	<a href="#">148</a>
DSI® Internal Hex Implant System	Zimmer® Screw-Vent / Tapered Screw-Vent 3.3 / 3.7 / 4.1mm (3.5mm Ø)	<a href="#">148</a>
DSI® Conical Orange NP	Nobel® Active / Conical Connection NP 3.5mm	<a href="#">125</a>
DSI® Conical Orange RP	Nobel® Active / Conical Connection RP 4.3/5.0mm	<a href="#">127</a>
Easy Implant Master® C 4.5/5.0	Hiossen® Regular 4.0 / 4.5 / 5.0mm	<a href="#">105</a>
Easy Implant Master® S 3.75/4.25/4.75	Hiossen® Regular 4.0 / 4.5 / 5.0mm	<a href="#">105</a>
Easy Implant Master® L 3.3/3.75/4.25/4.75	Hiossen® Regular 4.0 / 4.5 / 5.0mm	<a href="#">105</a>
Euroteknika® Aesthetica 4.1	Straumann® (Tissue Level) Standard RN (4.8mmD)	<a href="#">145</a>

All product names, logos, and brands are property of their respective owners. All company, product and service names are for identification purposes only. Use of these third-party names, logos, and brands does not imply, nor should it be understood as, any indication that the respective third-party brand owners have endorsed or sponsored, or are otherwise affiliated with or connected to, Preat or Preat's goods or services.

## Implant Compatibility Chart *(cont'd)*

System	Compatible With	Page
Euroteknika® Aesthetica 4.8	Straumann® (Tissue Level) Wide Neck (6.5mmD)	<a href="#">147</a>
Euroteknika Naturall	Astra 3.5-4.0 (Aqua)	<a href="#">79</a>
Glidewell Laboratories® Inclusive 3.5mm	Zimmer® Screw-Vent / Tapered Screw-Vent 3.3 / 3.7 / 4.1mm (3.5mm Ø)	<a href="#">148</a>
Glidewell Laboratories® Inclusive 4.5mm	Zimmer® Screw-Vent / Tapered Screw-Vent 4.7mm Diameter (4.5mm Ø)	<a href="#">150</a>
GT Medical®	Straumann® (Tissue Level) Standard RN (4.8mmD)	<a href="#">145</a>
Hahn Tapered® 3.0mm	Nobel® Active / Conical Connection 3.0mm	<a href="#">123</a>
Hahn Tapered® 3.5, 4.3mm	Nobel® Active / Conical Connection NP 3.5mm	<a href="#">125</a>
Hahn Tapered® 5.0mm	Nobel® Active / Conical Connection RP 4.3/5.0mm	<a href="#">127</a>
Hahn Tapered® 7.0mm	Nobel® Active / Conical Connection WP 5.0mm	<a href="#">129</a>
Hiossen® GS III Regular 4.0 / 4.5 / 5.0mm	Hiossen® Regular 4.0 / 4.5 / 5.0mm	<a href="#">105</a>
Hiossen® GS Ultra Wide 6.0 / 7.0mm	Hiossen® Regular 4.0 / 4.5 / 5.0mm	<a href="#">105</a>
Hiossen® SS I / II / III Regular 4.8mm	Straumann® SynOcta (Tissue Level) Standard RN (4.8mmD)	<a href="#">145</a>
Hiossen® SS III Wide 6.0mm	Hiossen® SS II Wide 6.0mm	
Hiossen® SS Ultra Wide 6.0mm	Hiossen® SS II Wide 6.0mm	
Hiossen® US II / III Plus Regular 4.1mm	Nobel® Branemark® RP 3.75 / 4.1mm	<a href="#">94</a>
Hiossen® US II / III Plus Wide 5.1mm	Nobel® Branemark® WP 5.1mm	
Hiossen® US II / III Regular 4.1mm	Nobel® Branemark® RP 3.75 / 4.1mm	<a href="#">94</a>
Hiossen® US II / III Wide 5.1mm	Nobel® Branemark® WP 5.1mm	
Hiossen® US II Mini 3.5mm	Nobel® Branemark® NP 3.3mm	
Hiossen® US II Plus Mini 3.5mm	Nobel® Branemark® NP 3.3mm	
Hiossen® US Mini 3.5mm	Nobel® Branemark® NP 3.3mm	
Hiossen® US Ultra Wide 5.1mm	Nobel® Branemark® WP 5.1mm	
Hi-Tec® Implex / Summitt 4.1mm	Nobel® Branemark® RP 3.75 / 4.1mm	<a href="#">94</a>
Hi-Tec® Logic 3.5mm	Nobel® Active / Conical Connection NP 3.5mm	<a href="#">125</a>
Hi-Tec® Logic 4.3 / 5.0mm	Nobel® Active / Conical Connection RP 4.3/5.0mm	<a href="#">127</a>
Hi-Tec® Logic Plus™	Zimmer® Screw-Vent / Tapered Screw-Vent 3.3 / 3.7 / 4.1mm (3.5mm Ø)	<a href="#">148</a>
Hi-Tec® Smooth & Slim Fit	Zimmer® Screw-Vent / Tapered Screw-Vent 3.3 / 3.7 / 4.1mm (3.5mm Ø)	<a href="#">148</a>
Hi-Tec® Tapered Self Thread 3.5mm	Zimmer® Screw-Vent / Tapered Screw-Vent 3.3 / 3.7 / 4.1mm (3.5mm Ø)	<a href="#">148</a>
Hi-Tec® Tapered Self Thread 4.5mm	Zimmer® Screw-Vent / Tapered Screw-Vent 4.7mm Diameter (4.5mm Ø)	<a href="#">150</a>
Hi-Tec® Tapered Tite Fit 4.8	Straumann® SynOcta (Tissue Level) Standard RN (4.8mmD)	<a href="#">145</a>
Hi-Tec® Tite Fit™	Straumann® SynOcta (Tissue Level) Standard RN (4.8mm Ø)	<a href="#">145</a>
Hi-Tec® Vision 3.5mm	Nobel® Replace Tri-Lobe NP 3.5mm	<a href="#">130</a>

The compatibility information referenced in these charts is based on published, available data and design equivalence. This information is intended to assist dental providers with treatment and diagnosis. Preat Corporation does not provide any diagnosis or suggested medical treatment in the report.

## Implant Compatibility Chart *(cont'd)*

System	Compatible With	Page
Hi-Tec® Vision 4.3mm	Nobel® Replace Tri-Lobe RP 4.3mm	<a href="#">132</a>
Hi-Tec® Vision 5.0mm	Nobel® Replace Tri-Lobe WP 5.0mm	<a href="#">134</a>
IBS® Magic FC/N.R Fix	Hiossen® Regular 4.0 / 4.5 / 5.0mm	<a href="#">105</a>
IDO Implant ®	Hiossen® Regular 4.0 / 4.5 / 5.0mm	<a href="#">105</a>
IDS Reflect® Aspire 3.5/4.0mm	Astra® Osseospeed 3.5/4.0s (AQUA)	<a href="#">79</a>
IDS Reflect® Aspire 4.5/5.0mm	Astra® Osseospeed 4.5/5.0s (LILAC)	<a href="#">81</a>
IDS Reflect® Rapid 3.5mm	Nobel® Active / Conical Connection NP 3.5mm	<a href="#">125</a>
IDS Reflect® Rapid 4.3mm	Nobel® Active / Conical Connection RP 4.3/5.0mm	<a href="#">127</a>
IDS Reflect® Rapid 5.0mm	Nobel® Active / Conical Connection WP 5.0mm	<a href="#">129</a>
IDS Reflect® Recover 3.5mm	Nobel® Active / Conical Connection NP 3.5mm	<a href="#">125</a>
IDS Reflect® Recover 4.3mm	Nobel® Active / Conical Connection RP 4.3/5.0mm	<a href="#">127</a>
IDS Reflect® Recover 5.0mm	Nobel® Active / Conical Connection WP 5.0mm	<a href="#">129</a>
IDS Reflect® Tapered 3.7-4.1	Zimmer® Screw-Vent / Tapered Screw-Vent 3.3 / 3.7 / 4.1mm (3.5mm Ø)	<a href="#">148</a>
IDS Reflect® Tapered 4.7	Zimmer® Screw-Vent / Tapered Screw-Vent 4.7mm Diameter (4.5mm Ø)	<a href="#">150</a>
Implanet®	Zimmer® Screw-Vent / Tapered Screw-Vent 3.3 / 3.7 / 4.1mm (3.5mm Ø)	<a href="#">148</a>
Implant Direct® InterActive™/Simply Iconic™ NP	Nobel® Active / Conical Connection NP 3.5mm	<a href="#">125</a>
Implant Direct® InterActive™/Simply Iconic™ RP	Nobel® Active / Conical Connection RP 4.3/5.0mm	<a href="#">127</a>
Implant Direct® Legacy™ 1/2/3/4 3.5mmD	Zimmer® Screw-Vent / Tapered Screw-Vent 3.3 / 3.7 / 4.1mm (3.5mm Ø)	<a href="#">148</a>
Implant Direct® Legacy™ 1/2/3/4 4.5mmD	Zimmer® Screw-Vent / Tapered Screw-Vent 4.7mm Diameter (4.5mm Ø)	<a href="#">150</a>
Implant Direct® Legacy™ 1/2/3/4 5.7mmD	Zimmer® Screw-Vent / Tapered Screw-Vent 5.7mm	<a href="#">152</a>
Implant Direct® RePlant® / RePlus® / ReActive® NP	Nobel® Replace Tri-Lobe NP 3.5mm	<a href="#">130</a>
Implant Direct® RePlant® / RePlus® / ReActive® RP	Nobel® Replace Tri-Lobe RP 4.3mm	<a href="#">132</a>
Implant Direct® RePlant® / RePlus® / ReActive® WP	Nobel® Replace Tri-Lobe WP 5.0mm	<a href="#">134</a>
Implant Direct® SwishPlant / SwishPlus (4.8mmD)	Straumann® SynOcta (Tissue Level) Standard RN (4.8mmD)	<a href="#">145</a>
Implant Genesis® Aktiv System	Zimmer® Screw-Vent / Tapered Screw-Vent 3.3 / 3.7 / 4.1mm (3.5mm Ø)	<a href="#">148</a>
Imtec® 3.40/ 3.75/ 4.0mm external hex	Nobel® Branemark RP 3.75 / 4.1mm	<a href="#">94</a>
IMZ® 3.3 / 4.0mm External Hex	Nobel® Branemark RP 3.75 / 4.1mm	<a href="#">94</a>
Innova® Endopore 4.1 / 5.0mm (One-Stage)	Straumann® SynOcta (Tissue Level) Standard RN (4.8mmD)	<a href="#">145</a>
Innova® Endopore 4.1mm	Nobel® Branemark RP 3.75 / 4.1mm	<a href="#">94</a>

All product names, logos, and brands are property of their respective owners. All company, product and service names are for identification purposes only. Use of these third-party names, logos, and brands does not imply, nor should it be understood as, any indication that the respective third-party brand owners have endorsed or sponsored, or are otherwise affiliated with or connected to, Preat or Preat's goods or services.

# Implant Compatibility Chart *(cont'd)*

System	Compatible With	Page
Innova Endopore 5.0mm / Entegra 4.7mm (0.7mm) Ext Hex	Biomet 3i® Osseotite XP 5.0mm WP	
Innova Entegra 3.25 - 4.1mm (0.7mm) External Hex	Nobel® Branemark® RP 3.75 / 4.1mm	<a href="#">94</a>
Innova Hex Plus 4.1mm	Nobel® Branemark® RP 3.75 / 4.1mm	<a href="#">94</a>
Innova Pro Series (TL) Tissue Level 4.1 / 4.8mm	Straumann® SynOcta (Tissue Level) Standard RN (4.8mmD)	<a href="#">145</a>
Innova Pro Series XRT Bone Level 4.8mm	Straumann® SynOcta (Tissue Level) Standard RN (4.8mmD)	<a href="#">145</a>
Intra-Lock 3.75 / 4.0mm External Hex	Nobel® Branemark RP 3.75 / 4.1mm	<a href="#">94</a>
Intra-Lock 4.3mm Standard Platform Conic Body	Straumann® SynOcta (Tissue Level) Standard RN (4.8mmD)	<a href="#">145</a>
J Dental Care JDEvolution	Zimmer® Screw-Vent / Tapered Screw-Vent 3.3 / 3.7 / 4.1mm (3.5mm Ø)	<a href="#">148</a>
Lifecore Stage One 3.3 / 4.1 / 4.8mm (RDS)	Straumann® SynOcta (Tissue Level) Standard RN (4.8mmD)	<a href="#">145</a>
Leader Tixos Internal Hex	Zimmer® Screw-Vent / Tapered Screw-Vent 3.3 / 3.7 / 4.1mm (3.5mm Ø)	<a href="#">148</a>
Luna RP 2.5mm	Hiossen® Regular 4.0 / 4.5 / 5.0mm	<a href="#">105</a>
MegaGen Anyone® RP (Internal)	Hiossen® Regular 4.0 / 4.5 / 5.0mm	<a href="#">105</a>
MegaGen ExFeel External Hex	Nobel® Branemark RP 3.75 / 4.1mm	<a href="#">94</a>
MegaGen ExFeel External Hex Small (3.5)	Nobel® Branemark NP 3.3mm	
MegaGen ExFeel External Hex Wide (5.0)	Biomet 3i® Osseotite XP 5.0mm WP	
MegaGen ExFeel Internal Straight/Taper (4.8)	Straumann® SynOcta (Tissue Level) Standard RN (4.8mmD)	<a href="#">145</a>
MIS C4 3.75 / 4.20mm	Zimmer® Screw-Vent / Tapered Screw-Vent 3.3 / 3.7 / 4.1mm (3.5mm Ø)	<a href="#">148</a>
MIS Lance External hex Standard Platform 4.1mm	Nobel® Branemark® RP 3.75 / 4.1mm	<a href="#">94</a>
MIS Lance External hex Wide Platform (5.0)	Biomet 3i® Osseotite XP 5.0mm WP	
MIS Mistral Internal Morse Taper One Stage RN	Straumann® SynOcta (Tissue Level) Standard RN (4.8mmD)	<a href="#">145</a>
MIS Seven 3.75 / 4.20mm	Zimmer® Screw-Vent / Tapered Screw-Vent 3.3 / 3.7 / 4.1mm (3.5mm Ø)	<a href="#">148</a>
MIS Seven 4.5	Zimmer® Screw-Vent / Tapered Screw-Vent 4.7mm Diameter (4.5mm Ø)	<a href="#">150</a>
Neobiotech IS Implant: System	Hiossen® Regular 4.0 / 4.5 / 5.0mm	<a href="#">105</a>
Neodent Titamax TI Medular (4.1)	Nobel® Branemark RP 3.75 / 4.1mm	<a href="#">94</a>
Neodent Titamax TI Medular (5.0)	Intra-Lock® Threaded Conic 4.75/ 5.0mm Ex Hex	
Noris Medical	Zimmer® Screw-Vent / Tapered Screw-Vent 3.3 / 3.7 / 4.1mm (3.5mm Ø)	<a href="#">148</a>
OsteoReady	Zimmer® Screw-Vent / Tapered Screw-Vent 3.3 / 3.7 / 4.1mm (3.5mm Ø)	<a href="#">148</a>
OSTEO Implant System External Hex	Nobel® Branemark® RP 3.75 / 4.1mm	<a href="#">94</a>
Osteoplus Shi	Zimmer® Screw-Vent / Tapered Screw-Vent 3.3 / 3.7 / 4.1mm (3.5mm Ø)	<a href="#">148</a>

The compatibility information referenced in these charts is based on published, available data and design equivalence. This information is intended to assist dental providers with treatment and diagnosis. Preat Corporation does not provide any diagnosis or suggested medical treatment in the report.

## Implant Compatibility Chart *(cont'd)*

System	Compatible With	Page
PALTOP® Advanced Classic	Zimmer Screw-Vent / Tapered Screw-Vent 3.3 / 3.7 / 4.1mm (3.5mm Ø)	<a href="#">148</a>
PALTOP® Advanced +	Zimmer Screw-Vent / Tapered Screw-Vent 3.3 / 3.7 / 4.1mm (3.5mm Ø)	<a href="#">148</a>
PALTOP® Dynamic	Zimmer Screw-Vent / Tapered Screw-Vent 3.3 / 3.7 / 4.1mm (3.5mm Ø)	<a href="#">148</a>
PALTOP® DIVA	Zimmer® Screw-Vent / Tapered Screw-Vent 3.3 / 3.7 / 4.1mm (3.5mm Ø)	<a href="#">148</a>
PALTOP® Conical Active	Hiossen® GS II & GS III Mini 3.5mm	<a href="#">103</a>
Paragon® Bio-Vent 3.5mm Diameter (3.5mm D)	Zimmer® Screw-Vent / Tapered Screw-Vent 3.3 / 3.7 / 4.1mm (3.5mm Ø)	<a href="#">148</a>
Paragon® Bio-Vent 4.5mm Diameter (4.5mm D)	Zimmer® Screw-Vent / Tapered Screw-Vent 4.7mm Diameter (4.5mm Ø)	<a href="#">150</a>
Paragon® Core-Vent 4.3mm Diameter (3.5mm D)	Zimmer® Screw-Vent / Tapered Screw-Vent 3.3 / 3.7 / 4.1mm (3.5mm Ø)	<a href="#">148</a>
Paragon® Core-Vent 5.3mm Diameter (4.5mm D)	Zimmer® Screw-Vent / Tapered Screw-Vent 4.7mm Diameter (4.5mm Ø)	<a href="#">150</a>
Paragon® Micro-Vent 3.25mm Diameter (3.5mm D)	Zimmer® Screw-Vent / Tapered Screw-Vent 3.3 / 3.7 / 4.1mm (3.5mm Ø)	<a href="#">148</a>
Paragon® Micro-Vent 4.25mm Diameter (4.5mm D)	Zimmer® Screw-Vent / Tapered Screw-Vent 4.7mm Diameter (4.5mm Ø)	<a href="#">150</a>
Paragon® Swede-Vent (TL) 4.0mm	Nobel® Branemark® RP 3.75 / 4.1mm	<a href="#">94</a>
Paragon® Swede-Vent 4.0mm	Nobel® Branemark® RP 3.75 / 4.1mm	<a href="#">94</a>
Paragon® Swiss Plus 4.8mm	Straumann® SynOcta (Tissue Level) Standard RN (4.8mmD)	<a href="#">145</a>
Paragon® Taperlock	Nobel® Branemark® RP 3.75 / 4.1mm	<a href="#">94</a>
Park Dental Research® Star Vent External Hex Screw (3.3)	Steri-Oss® Hex Lock 3.25mm	
Park Dental Research® Star Vent External Hex Screw (4.1)	Nobel® Branemark® RP 3.75 / 4.1mm	<a href="#">94</a>
Park Dental Research® Star Vent External Hex Screw (5.0)	Intra-Lock® Threaded Conic 4.75/ 5.0mm Ex Hex	
Park Dental Research® Star Vent External Hex Screw (5.0)	Intra-Lock® Threaded Conic 4.75/ 5.0mm Ex Hex	
ProClinic® Cylindrical/Conical Internal	Zimmer® Screw-Vent / Tapered Screw-Vent 3.3 / 3.7 / 4.1mm (3.5mm Ø)	<a href="#">148</a>
ProClinic® SP Octa 4.8	Straumann® (Tissue Level) Standard RN (4.8mmD)	<a href="#">145</a>
ProClinic® SP Octa 6.5	Straumann® (Tissue Level) Wide Neck (6.5mmD)	<a href="#">147</a>
Renew Biocare® Re-Root SD 3.5mm	Straumann® SynOcta (Tissue Level) Standard NN (3.5mmD)	
Restore® / Sustain® SD 3.3 mm External Hex	Steri-Oss® Hex Lock 3.25mm	
Restore® / Sustain® SD 3.75 / 4.0 / 4.2mm External Hex	Nobel® Branemark® RP 3.75 / 4.1mm	<a href="#">94</a>
Restore® / Sustain® SD 5.0mm External Hex	Intra-Lock® Threaded Conic 4.75/ 5.0mm Ex Hex	
Ritter™ Implants (3.5-6.0mm)	Zimmer® Screw-Vent / Tapered Screw-Vent®	<a href="#">148</a>
SGS Dental® P1/P7	Zimmer® Screw-Vent / Tapered Screw-Vent 3.3 / 3.7 / 4.1mm (3.5mm Ø)	<a href="#">148</a>
SGS Dental P1, P7	Zimmer® Screw-Vent / Tapered Screw-Vent® 3.3 / 3.7 / 4.1mm (3.5mm )	<a href="#">148</a>
Sigma Active Classic	Zimmer® Screw-Vent / Tapered Screw-Vent®	<a href="#">148</a>
Sigma Mega X	Hiossen® Regular 4.0/4.5/5.0mm	<a href="#">105</a>
Simply Implants®	Zimmer® Screw-Vent / Tapered Screw-Vent 3.3 / 3.7 / 4.1mm (3.5mm Ø)	<a href="#">148</a>
Southern® 12 degrees 4.3 (3.5mmD)	Nobel® Replace Tri-Lobe NP 3.5mm	<a href="#">130</a>

All product names, logos, and brands are property of their respective owners. All company, product and service names are for identification purposes only. Use of these third-party names, logos, and brands does not imply, nor should it be understood as, any indication that the respective third-party brand owners have endorsed or sponsored, or are otherwise affiliated with or connected to, Preat or Preat's goods or services.

# Implant Compatibility Chart *(cont'd)*

System	Compatible With	Page
Southern® 12 degrees 5.0 (4.3mmD)	Nobel® Replace Tri-Lobe RP 4.3mm	<a href="#">132</a>
Southern® 12 degrees 7.0 (5.0mmD)	Nobel® Replace Tri-Lobe WP 5.0mm	<a href="#">134</a>
Southern® CoAxis OCT-XT / MAX-IT 4.0 / 5.0mm (4.8mmD)	Straumann® SynOcta (Tissue Level) Standard RN (4.8mmD)	<a href="#">145</a>
Southern® CoAxis OCT-XT / MAX-IT 6.0mm (6.5mmD)	Straumann® SynOcta (Tissue Level) Standard WN (6.5mmD)	<a href="#">147</a>
Southern® CoAxis TriNeck / TriMax 6.0 / 8.0 / 9.0 (6.0mmD)	Nobel® Replace Tri-Lobe 6.0mm	<a href="#">136</a>
Southern® CoAxis TriNeck / TriMax NP	Nobel® Replace Tri-Lobe NP 3.5mm	<a href="#">130</a>
Southern® CoAxis TriNeck / TriMax RP	Nobel® Replace Tri-Lobe RP 4.3mm	<a href="#">132</a>
Southern® CoAxis TriNeck / TriMax WP	Nobel® Replace Tri-Lobe WP 5.0mm	<a href="#">134</a>
Southern® Parallel / Tapered External Hex NP	Nobel® Branemark NP 3.3mm	
Southern® Parallel / Tapered External Hex WP	Biomet 3i® Osseotite XP 5.0mm WP	
Spiral Tech Premium	NobelBiocare™ NobelReplace™ Tri-Lobe	<a href="#">130</a>
Spiral Tech Ultimate	NobelBiocare™ NobelActive™ Conical	<a href="#">123</a>
Steri-Oss® (no-hex) Flat Top 3.8mm	Calcitek® Integral 4.0mm	
Steri-Oss® Hex Lock 3.8 / 4.5mm	Nobel® Branemark® RP 3.75 / 4.1mm	<a href="#">94</a>
Sterngold® Hex Cylinder 3.3 / 4.0mm	Nobel® Branemark® RP 3.75 / 4.1mm	<a href="#">94</a>
Sterngold® Hex Screw 3.75 / 4.0 / 5.0mm	Nobel® Branemark® RP 3.75 / 4.1mm	<a href="#">94</a>
Sterngold® IC 3.3 / 4.1 / 4.8mm	Straumann® SynOcta (Tissue Level) Standard RN (4.8mmD)	<a href="#">145</a>
Sterngold® PUR NP	Zimmer® Screw-Vent / Tapered Screw-Vent 3.3 / 3.7 / 4.1mm (3.5mm Ø)	<a href="#">148</a>
Sterngold® PUR RP	Zimmer® Screw-Vent / Tapered Screw-Vent 4.7mm Diameter (4.5mm Ø)	<a href="#">150</a>
Sterngold® TRU NP	Nobel® Active / Conical Connection NP 3.5mm	<a href="#">125</a>
Sterngold® TRU RP	Nobel® Active / Conical Connection RP 4.3/5.0mm	<a href="#">127</a>
Surgikor® Fixation™ Conical	NobelBiocare™ NobelActive™ Conical RP	<a href="#">127</a>
Surgikor® Immediate™ Hex, Versatile™ Hex	Zimmer® Screw-Vent®/Tapered Screw-Vent 3.3/3.7/4.1mm (3.5mm )	<a href="#">148</a>
Surgikor® Hex Regular and Wide	Zimmer® Screw-Vent / Tapered Screw-Vent 3.3 / 3.7 / 4.1mm (3.5mm Ø)	<a href="#">148</a>
Sustain® 4.0 / 4.7mm Internal Bevel (flat top)	Calcitek® Integral 4.0mm	
Sybron® Hex Plus 3.5mm	Nobel® Branemark® NP 3.3mm	
Sybron® Hex Plus 5.1mm	Nobel® Branemark® WP 5.1mm	
Sybron® Pitt Easy 3.8 (3.75mm D)(Yellow)	Sybron® Pitt Easy 3.3 (3.25mm D)(Green)	
Sybron® Pitt Easy 4.1 (4.0mm D)(Red)	Sybron® Pitt Easy 3.3 (3.25mm D)(Green)	
Sybron® Pitt Easy 4.9mm (Blue)	Sybron® Pitt Easy 3.3 (3.25mm D)(Green)	
The Little Implant Company®	Zimmer® Screw-Vent / Tapered Screw-Vent 3.3 / 3.7 / 4.1mm (3.5mm Ø)	<a href="#">148</a>
Tre-Oss® Simple	Zimmer® Screw-Vent / Tapered Screw-Vent 3.3 / 3.7 / 4.1mm (3.5mm Ø)	<a href="#">148</a>
Tri Dental Implants®	Zimmer® Screw-Vent / Tapered Screw-Vent 3.3 / 3.7 / 4.1mm (3.5mm Ø)	<a href="#">148</a>
Uni-Dental Direct® IN-SIX	Zimmer® Screw-Vent / Tapered Screw-Vent 3.3 / 3.7 / 4.1mm (3.5mm Ø)	<a href="#">148</a>

The compatibility information referenced in these charts is based on published, available data and design equivalence. This information is intended to assist dental providers with treatment and diagnosis. Preat Corporation does not provide any diagnosis or suggested medical treatment in the report.

## Torque Values

System	Prosthetic Screw Connection	Prosthetic Screw Thread	Manufacturer Recommended Torque
<b>3i®</b>			
3i Certain Internal	0.048" (1.22mm) Hex	M1.6 x 0.35	20 Ncm
3i Certain External	Square	M2 x 0.40	32-35 Ncm
<b>Ankylos®</b>			
C/X	1mm Hex	M1.8 x 0.35	15 Ncm
<b>Astra®</b>			
Astra 3.0	0.050" (1.27mm) Hex	M1.4 x 0.30	15 Ncm
Astra 3.5-4.0 (Aqua)	0.050" (1.27mm) Hex	M1.6 x 0.35	20 Ncm
Astra 4.5-5.0 (Lilac)	0.050" (1.27mm) Hex	M2 x 0.40	25 Ncm
Astra EV 3.0, 3.6, 4.2, 4.8, 5.4	0.050" (1.27mm) Hex		25 Ncm
<b>BioHorizons®</b>			
External, Internal, Internal Tapered	0.050" (1.27mm) Hex		30 Ncm
<b>BlueSky Bio®</b>			
One Stage	Star & 0.048" (1.20mm) Hex		30 Ncm
Trilobe	Unigrip & 0.048" (1.20mm) Hex		30 Ncm
Internal Hex & Molar	0.050" (1.27mm) Hex		30 Ncm
Conus 12 & Three	0.050" (1.27mm) Hex		30 Ncm
Max	0.048" (1.20mm) Hex		30 Ncm
Quatro	0.048" (1.20mm) Hex		30 Ncm
<b>Camlog® ScrewLine</b>			
3.3, 3.8, 4.3mm	0.050" (1.27mm) Hex	M1.6 x 0.35	20 Ncm
5.0, 6.0mm	0.050" (1.27mm) Hex	M2 x 0.40	20 Ncm
<b>Endopore</b>			
Endopore (Sybron)	0.050" (1.27mm) Hex		30 Ncm
<b>Dentsply®</b>			
Fridadent/Frialit & Xive	0.048" (1.20mm) Hex		24 Ncm
<b>Hiossen®</b>			
Mini	0.048" (1.20mm) Hex	M1.6 x 0.35	20 Ncm
Regular	0.048" (1.20mm) Hex	M2 x 0.40	30 Ncm
<b>Implant Direct®</b>			
Legacy™ 3.0mm	0.050" (1.27mm) Hex	M1.6 x 0.35	30 Ncm

## Torque Values (cont'd)

System	Prosthetic Screw Connection	Prosthetic Screw Thread	Manufacturer Recommended Torque
<b>Keystone®</b>			
Keystone Prima Connex	Square	M1.8 x 0.35	30 Ncm
SD Restore	0.048" (1.20mm) Hex, Square	Square 1-72 UNF	30 Ncm
RD Restore	0.048" (1.20mm) Hex, Square	M2 x 0.40	30 Ncm
WD Restore 0.048" (1.22mm) Hex, Square	0.048" (1.20mm) Hex, Square	M2.5 x 0.45	30 Ncm
Keystone Renova	0.048" (1.20mm) Hex	M1.8 x 0.35	30 Ncm
<b>MegaGen®</b>			
Anyridge®	0.048" (1.20mm) Hex	M1.8 x 0.35	25 Ncm
<b>Neodent®</b>			
Neodent® CM	0.048" (1.20mm) Hex	M1.8 x 0.35	32 Ncm
Neodent® GM	Neo Screwdriver		20 Ncm
<b>Neoss®</b>			
Neoss®	Neoss Proprietary	M2 x 0.40	32 Ncm
<b>Nobel Biocare®</b>			
NobelActive™ 3.0	Unigrip	M1.4 x 0.30	15 Ncm
NobelActive™ NP	Unigrip	M1.6 x 0.35	35 Ncm
NobelActive™ RP/WP	Unigrip	M2 x 0.40	35 Ncm
Branemark NP	Unigrip	M1.6 x 0.35	35 Ncm
Branemark RP	Unigrip	M2 x 0.40	35 Ncm
Branemark WP	Unigrip	M2.5 x 0.45	35 Ncm
NobelReplace™ NP	Unigrip	M1.8 x 0.35	35 Ncm
NobelReplace™ RP	Unigrip	M2 x 0.40	35 Ncm
<b>Straumann® Tissue-level</b>			
Narrow Neck SCS	SCS	M1.8 x 0.35	35 Ncm
Regular Neck SCS	SCS	M2 x 0.40	35 Ncm
Wide Neck	SCS	M2 x 0.40	35 Ncm
<b>Straumann® Bone-level</b>			
Narrow Cross-fit SCS	SCS	M1.6 x 0.35	35 Ncm
Regular Cross-fit SCS	SCS	M1.6 x 0.35	35 Ncm
<b>Straumann® BLX</b>			
RB/WB	SCS	M1.6 x 0.66	35 Ncm
<b>Zimmer®</b>			
Zimmer® ScrewVent	0.050" (1.27mm) Hex	1-72 UNF	30 Ncm

Preat  
**PATIENT-SPECIFIC  
ABUTMENTS**

# Elevating Your Restorations TO THE HIGHEST DEGREE

Preat is setting the standard with advanced Patient-Specific Abutment solutions. With our innovative angled screw channel abutment, offering up to 30° of angulation, we're not just supporting your workflow – we're empowering your ability to provide the best restorations possible!

From fully validated in-house milling to expert overflow and outsourcing support, you have the freedom to own your own strategy, meeting your needs today and accelerating your growth tomorrow.



## COMPATIBILITY

All Major Implant Systems



## QUALITY

Fit Meets or Exceeds OEM



## SPEED

Two-Day Turnaround Time



## PROTECTION

All OEM Implant Warranties Matched

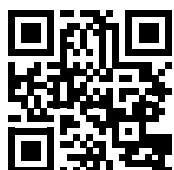
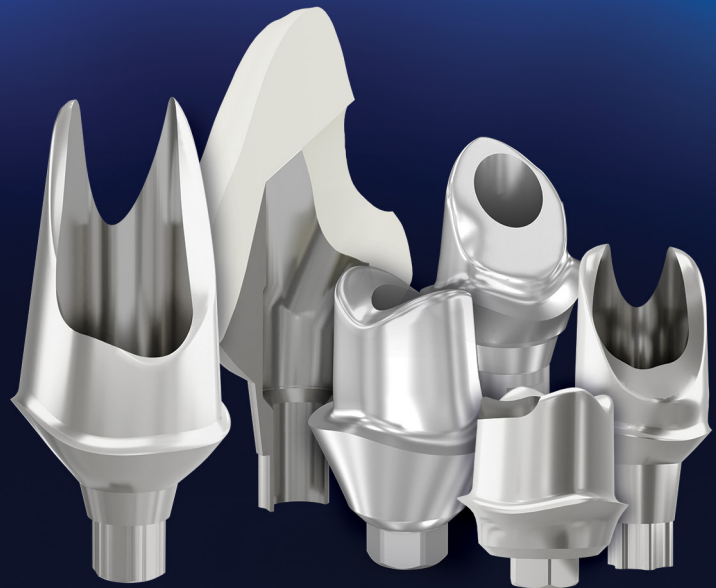

## LEARN MORE

visit us at [www.preat.com/preat-patient-specific-abutments](http://www.preat.com/preat-patient-specific-abutments)  
to discover Preat Patient-Specific Abutments

# Your Honorary Team Member

*Let us be your implant restoration expert. We've spent decades developing knowledge of the many restorative solutions available on the market and instilling that expertise within our team. We believe in helping patients access the best care possible and approach each question with that in mind.*

## Connect on Your Terms

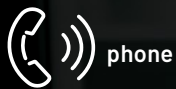

**Within The USA  
Customer Service**

**6am - 5pm PST**  
t: 1.800.232.7732 | f: 805.202.3076 | [www.preat.com](http://www.preat.com)

**Outside The USA  
Customer Service**

**6am - 5pm PST**  
t: +1.805.202.3070 | f: +1.805.202.3076

**Technical Support**

[technical@preat.com](mailto:technical@preat.com)

**Customer Support**

[info@preat.com](mailto:info@preat.com)

**Orders**

[orders@preat.com](mailto:orders@preat.com)



**PREAT.COM • 800.232.7732**

All product names, logos, and brands are property of their respective owners. All company, product and service names are for identification purposes only. Use of these third-party names, logos, and brands does not imply, nor should it be understood as, any indication that the respective third-party brand owners have endorsed or sponsored, or are otherwise affiliated with or connected to, Preat or Preat's goods or services.

©2025 Copyright Preat Corporation • All rights reserved • Specifications are subject to change without notice.

Rev. 1/26